

louis poulsen

PANTHELLA 160 PORTABLE

DESIGNED BY
VERNER PANTON

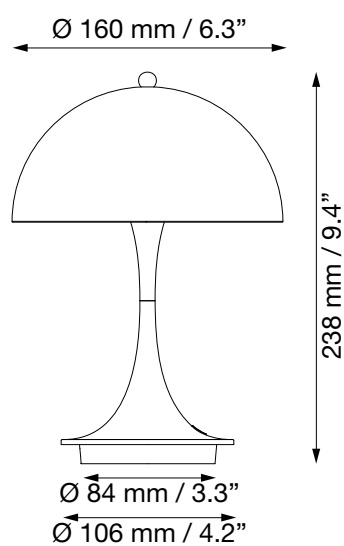

Lyskilde Light source Leuchtmittel Ljuskälla Sorgenti luminose Source lumineuse Fuente de luz Valonlähde ランプ	Spænding/frekvens Voltage/frequency Spannung/frequenz Spänning/frekvens Tensione/frequenza Voltage/frequence Tensión/frecuencia Jännite/taajuus 電源電圧 / 周波数	Vægt Weight Gewicht Vikt Peso/ingombro Poids Peso Paino 重さ	Isolationsklasse Protection Class Schutzklasse Isolationsklass Classe di isolamento Protection au choc électrique Clase de aislamiento Eristysluokka 保護クラス	Tæthedsklasse Ingress protection Schutzart Kapslingsklass Grado di protezione Indice de protection Clase de protección Koteloitiluokka 密度クラス
LED 2,5W 	DC 5V  1.5A SELV	Max. 0,5 kg / 1.1 lbs	Cl. III	IP44

DA

Støv aftørres med en tør, blød klud. Fedtpletter og lignende kan fjernes med en blød klud opvredet i lunkent vand (<50° C) tilsat mildt rengøringsmiddel. Brug aldrig rengøringsmidler, der indeholder slibemiddel, opløsningsmidler, alkohol eller syre. Efter udpakning bør lampen oplades inden brug. Genopladelige batterier vedligeholdes bedst ved jævnlig opladning.

EN

Wipe off dust with a dry, soft cloth. Remove greasy spots etc. with a soft cloth dampened in lukewarm water (<50° C) with a mild detergent. Never use detergents containing abrasives, solvents, alcohol or acid. After unpacking, the lamp should be charged before use. Rechargeable batteries are best maintained by regular charging.

DE

Staub bitte mit einem trockenen, weichen Lappen abwischen. Fettflecke und dgl. mit einem feuchten, in lauwarmem Wasser (<50° C) mit mildem Reinigungsmittel ausgewrungenen Lappen entfernen. Verwenden Sie niemals Reinigungsmittel, die Schleifmittel, Lösungsmittel, Alkohol oder Säure enthalten. Nach dem Auspacken muss die Lampe vor Gebrauch aufgeladen werden. Wiederaufladbare Batterien sollten regelmäßig aufgeladen werden, um ihre Leistungsfähigkeit zu erhalten.

SV

Lampan dammtorkas med en torr, mjuk trasa. Fettfläckar tas bort med ljummet vatten (<50° C) utblandat med mildt rengöringsmedel. Använd aldrig rengöringsmedel som innehåller slipmedel, lösningsmedel, alkohol eller syra. Efter uppäckning ska lampan laddas före användning. Laddningsbara batterier underhålls bäst genom regelbunden laddning.

IT

Pulire la polvere esterna con un panno morbido e asciutto. Rimuovere macchie di grasso ecc. con un panno morbido inumidito in acqua tiepida (<50° C) e con un detergente leggero. Non utilizzare mai detersivi contenenti abrasivi, solventi, alcool o acidi. Una volta disimballata, la lampada deve essere caricata prima dell'uso. Le batterie ricaricabili si mantengono al meglio ricaricandole periodicamente.

FR

Essuyez la poussière avec un chiffon sec et doux. Enlevez les points de saleté etc. avec un chiffon doux imprégné d'eau claire tiède et de détergent doux. N'employez jamais de détergents contenant des substances abrasives, des solvants, de l'alcool ou de l'acide. Après le déballage, la lampe doit être chargée avant utilisation. Il est préférable d'entretenir les batteries rechargeables en les chargeant régulièrement.

ES

Limpiar con paño seco y suave. Quitar manchas de grasa y otras con paño suave humedecido con agua templada (<50° C) con detergente poco agresivo. No utilice nunca detergentes que contengan agentes abrasivos, disolventes, alcohol o ácido. Después de desembalarla, la lámpara debe cargarse antes de usarla. Las baterías recargables se conservan mejor cargándolas de forma regular.

FI

Pyyhi pölyt kuivalla pehmeällä liinalla. Poista rasvatahrat miedolla pesuaineella ja haalealla vedellä (<50° C) kostutetulla pehmeällä liinalla. Älä koskaan käytä puhdistusaineita, jotka sisältävät hankaavia aineita, liuottimia, alkoholia tai happoa. Kun valaisin on purettu pakkauksesta, se on ladattava ennen käyttöä. Ladattavat akut pysyvät kunnossa parhaiten, kun ne ladataan säännöllisesti.

JP

ホコリは乾いた柔らかい布で拭き取ってください。塗装部分の油污れ等は、中性洗剤を溶かしたぬるま湯(50℃以下)に柔らかい布を浸し、よくしぼってから拭き取ってください。シンナー・ベンジン等の揮発物や、つや出し剤・研磨剤、溶剤、アルコール、酸を含む洗剤は絶対に使用しないでください。開梱後、使用前にランプを充電する必要があります。充電式バッテリーは定期的に充電することで最適に保つことができます。

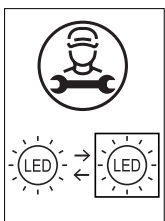

Replaceability

DA

Lyskilde og batteri i dette armatur må kun udskiftes af producenten, producentens service agent eller en lignende kvalificeret person.

EN

The light source and battery contained in this luminaire shall only be replaced by the manufacturer, the manufacturer's service agent or a similar qualified person.

DE

Die Lichtquelle und die in diesem Leuchten enthaltene Batterie dürfen nur vom Hersteller oder seinem Servicemittel oder einer ähnlichen qualifizierten Person ersetzt werden.

SV

Ljuskällan och batteriet i denna armatur får endast bytas ut av tillverkaren eller dennes serviceombud eller liknande kvalificerad person.

IT

La sorgente luminosa e la batteria contenuta in questo apparecchio può essere sostituita solo dal produttore o dal suo agente di assistenza o da una persona qualificata.

FR

La source lumineuse et la batterie contenue dans ce luminaire ne doit être remplacée que par le fabricant ou son agent de service ou une personne qualifiée similaire.

ES

La fuente de luz y la batería contenida en esta luminaria solo debe ser reemplazada por el fabricante o su agente de servicio o una persona calificada similar.

FI

Vain valmistaja tai tämän huoltoedustaja tai vastaava pätevä henkilö saa vaihtaa tämän valaisimen sisältämän valonlähteen.

JP

この照明器具に含まれる光源とバッテリーは、メーカー、そのサービスエージェント、または同様の資格を持つものだけに置き換えられます。



LOUIS POULSEN A/S
KUGLEGAARDSVEJ 19-23,
1434 COPENHAGEN K, DENMARK
TEL. +45 70 33 14 14
INFO@LOUISPOULSEN.DK
WWW.LOUISPOULSEN.COM



louis poulsen

ESTABLISHED 1874

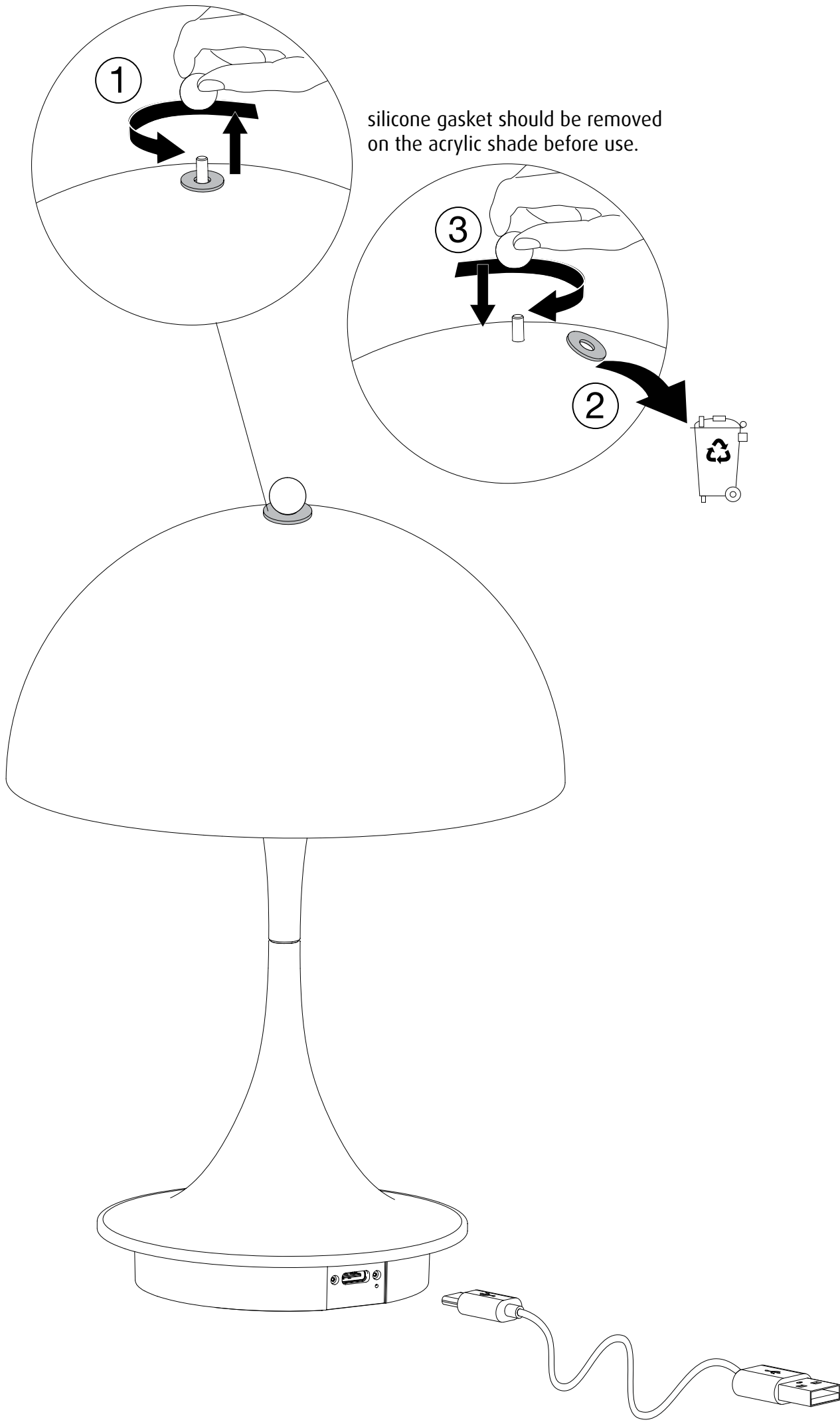
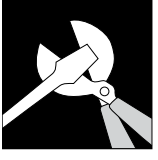

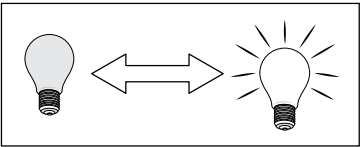
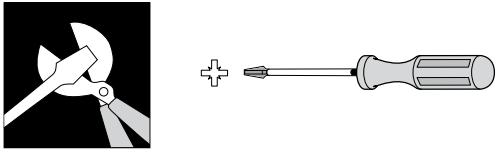

Power on/dimming:

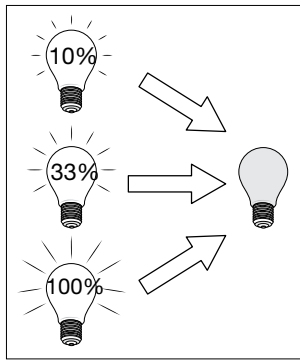
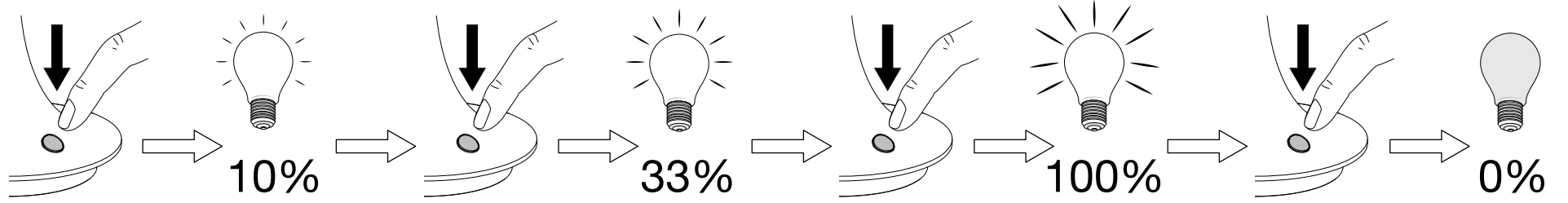

Power off:

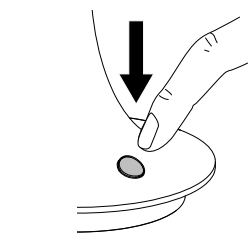

Press and hold 0,5 sec

Lock:

Choose:

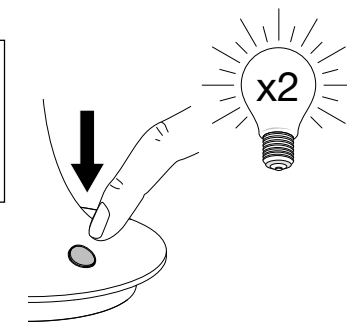

Press and hold >5 sec

Unlock:

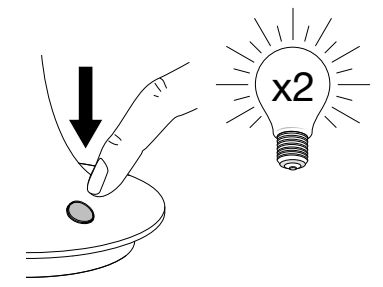

Press and hold >5 sec

Low battery level:

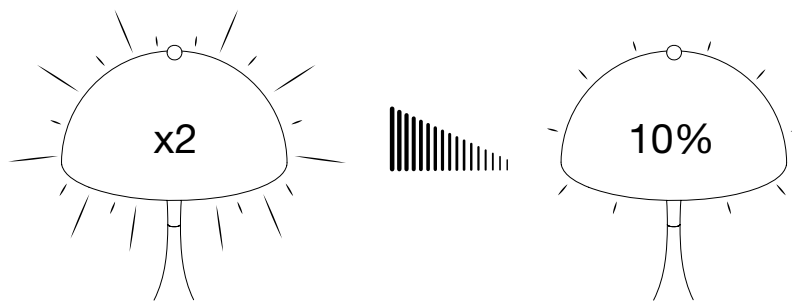

Charging:

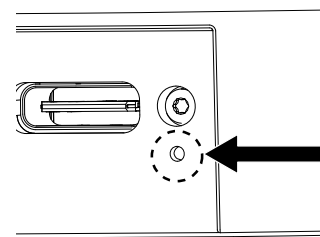
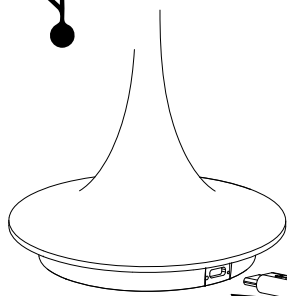
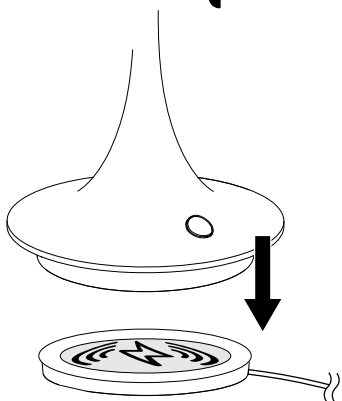

Adapter min. 1.5A

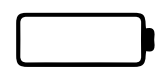

Replace batteries:

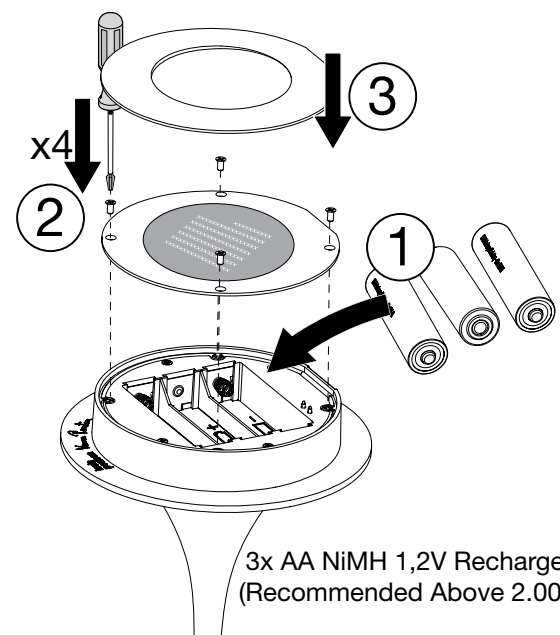
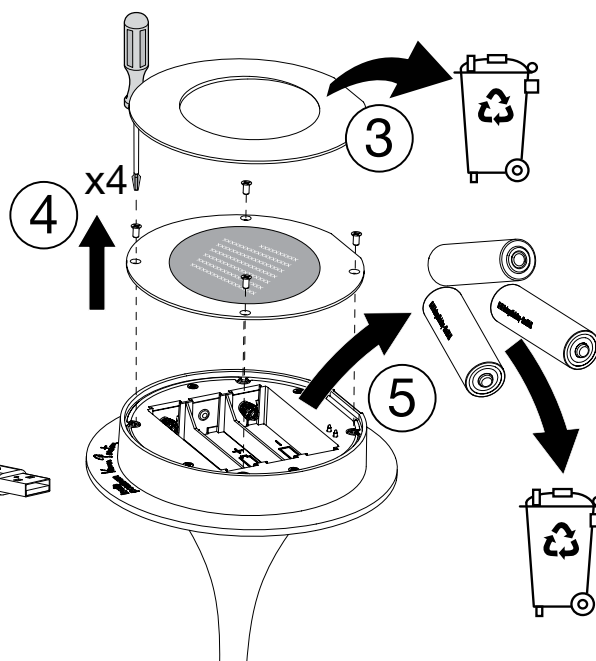
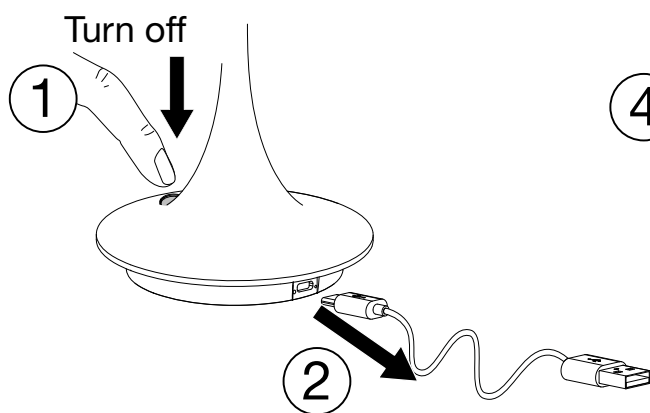

3x AA NiMH 1,2V Rechargeable (Recommended Above 2.000 mAh)

