

PANTHELLA 160 PORTABLE

Panthella 160 Portable - 5744166768

This portable table lamp emits a glare-free, soft, and comfortable light. The metal shade variants reflects the light downwards and provides pleasant illumination created by the inner white painted shade and the reflection from the trumpet-shaped stem. The opal acrylic variants provides gentle illumination and subtle ambience due to the transparency and the reflection of the downward light on the inner side of the shade.

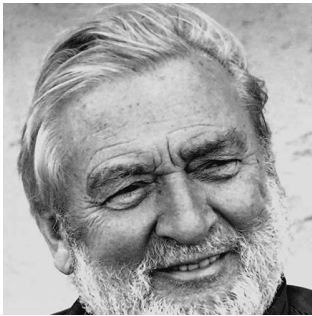
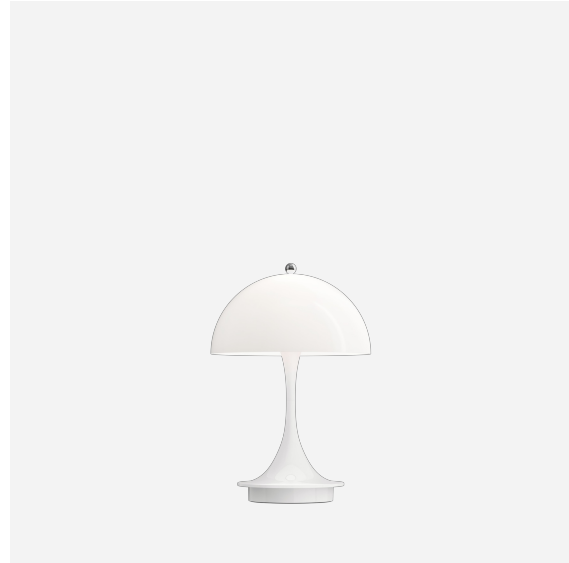

Verner Panton

Verner Panton (1926-1998) is famous for his inspirational and colorful personality. A unique person with a special sense for color, shape, light function and space. Over the course of his career, Panton introduced a series of modern lamps with personalities unlike any of his Scandinavian contemporaries.



**louis
poulsen**

Product info

Environmental Product Specification

This product is compliant with the requirements contained in the European Directives, RoHS Directive 2011/65 and 2015/863. This product is designed so that 100% of the product can be disassembled and reused.

Information

Please note that Panthella Portable comes with a USB cable but without adapter and Qi charger. Separate USB adapter is available as accessory. Compatible with standard USB adapters (Min 1.5A) and Qi wireless chargers.

Mounting

USB-C cable for standard USB-C adapter (min. 1.5A) or Qi wireless charger. White light indicator on base when charging. Light control: Switch on base. Batteries: 3 x AA NIMH, rechargeable and replaceable. Battery lifetime: 5 hours @ 100%. Step dim, short press: 0%/10%/33%/100%. Function to set a fixed light level.

Finish

Opal acrylic shade in White, Pale Rose or Pale Blue with matching stand. Grey Opal Acrylic shade with high lustre chrome stand. Pale Rose, Pale Blue or Coral, powder coated.

Materials

Shade: Deep drawn steel or injection moulded opal acrylic. Base and housing: Die cast aluminium

Sizes and weights

Width x Height x Length (mm) | 160 x 232 x 160 Max 0.4 kg | 160 x 238 x 160 Max 0.4 kg

Class

Ingress protection IP44. Electric shock protection III.

Light source

LED 2700K 2.5W

Lumen: 150

Information

Please note that Panthella Portable comes with a USB cable but without adapter and Qi charger. Separate USB adapter is available as accessory. Compatible with standard USB adapters (Min 1.5A) and Qi wireless chargers.



Related products



Panthella 400 Table Lamp



Panthella Floor



Panthella 250 Table Lamp

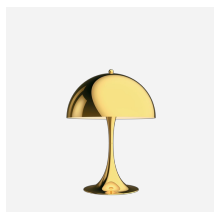

Panthella 320 Table Lamp

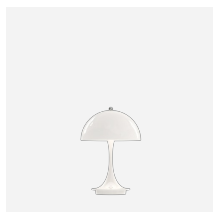

Panthella 160 Portable Metal

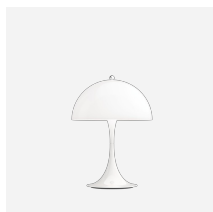

Panthella 250 Portable

Light distribution diagrams

Cartesian

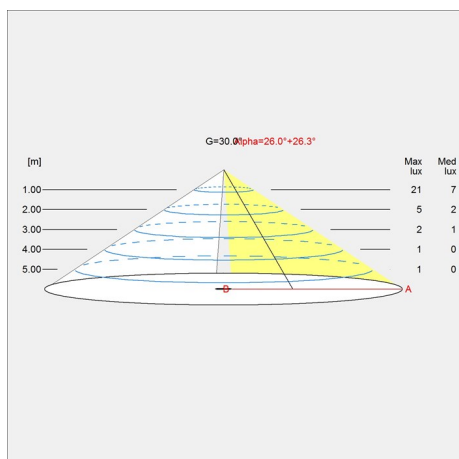

Isolux

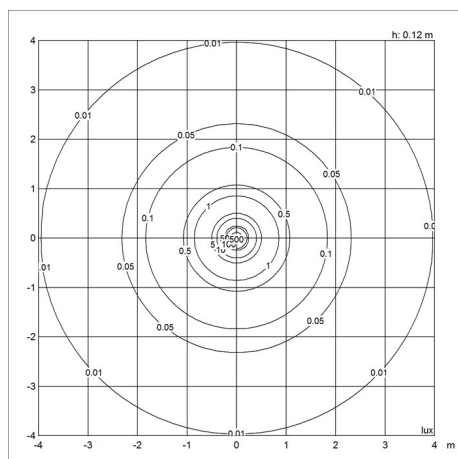

Polar

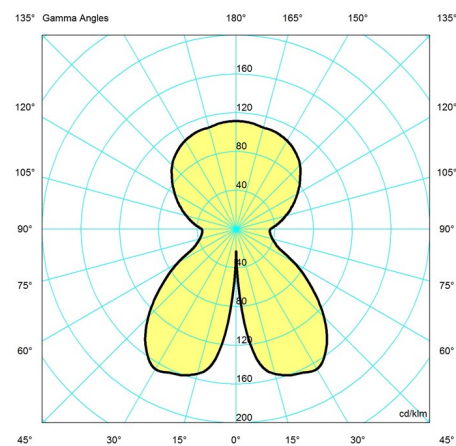

Spare parts & accessories

Product	Variant number
Panthella 160 USB adaptor, white	5744166674
Panthella 160 Opal shade	5744166742
Panthella 160 top nut	5744166755
Panthella 160 diffuser w/screws	5744168083
Panthella 160 White shade	5744168368
Panthella 160 Black shade	5744168371
Panthella 160 Orange shade	5744168384
Panthella 160 USB cover, black	5744168407
Black USB adaptor	5744168410
Panthella 160 V2 Rep. Kit Print	5744166739
Panthella 160 Opal Grey shade	5744168096
Panthella 160 Pale Blue shade	5744612665
Panthella 160 Coral shade	5744612678
Panthella 160 V2 Rubber Pad w/screws	5744612762
Panthella 160 Pale Rose shade	5744902090
Panthella 160 V2 Rep. Kit LED	5744168106
Panthella 160 Portable V2 Batt. Rep. Kit	5744620039

Data specifications

PantheLLa 160 Portable

Colour	White opal acryl
Width	160
Built-in Height	-
Class	III
Standby (W)	-
Inrush Current	-
Kelvin	2700
SDCM	3
Watt	2.5
Light control	-
UGR Transversal / Axial	9.1/9.1
Driver life	>50.000

Length	160
Height	238
IP class	44
Net Weight	0.4
Power Factor (P = 100 % / P = 50 %)	-
Light source	LED 2700K 2.5W
CRI	90
Lumen	150
Efficacy	60
Min. Dim Level (%)	33
L80B50 (hours)	>35.000