

instruction manual hanging lamp n°3

V9015030 I / R / Z

valerie objects

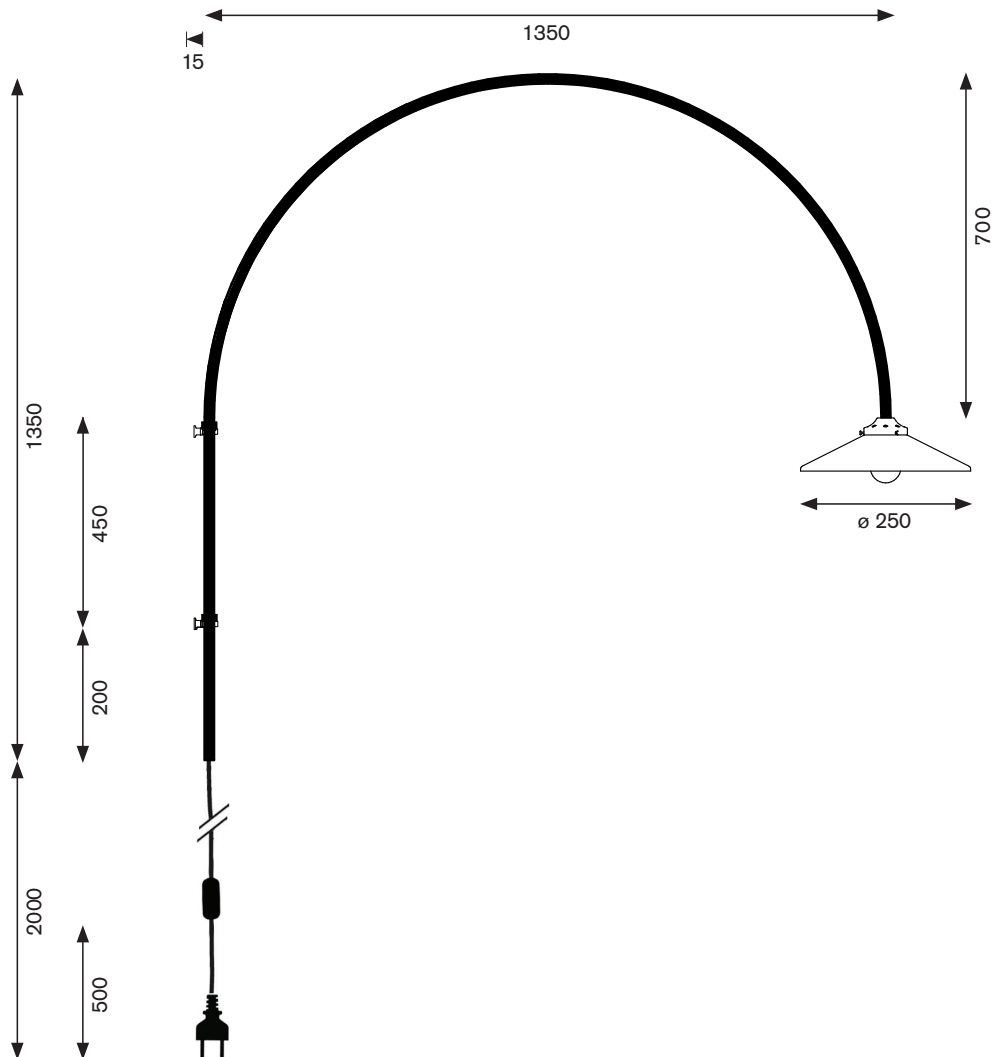

protection class 1:
the fitting must be earthed



the maximum wattage indicated
in each lighting unit, for example,
must not be exceeded



for indoor use only, where direct
contact with water is impossible



this luminaire was designed to
work only with the indicated
voltage



observe the indicated minimum
distance between the lamp and
the illuminated materials/objects



the armature can be used in
combination with a dimmer.
consult the sales outlet for the
correct type



not to be disposed with domestic
waste in rubbish bin, bring it to a
staging area for electrical waste

safety directions

Please study the instruction manual carefully before installing or using this product.
Keep this user manual for further reference / two persons needed for installation.

1. The luminaires may only be installed by authorized and qualified technicians according to valid regulations for electrical installation.
2. Maintenance of the luminaires is limited to their surfaces. During maintenance no moisture can come into contact with any areas of the terminal connections or voltage control parts.
3. Take account of the minimal separation distance from other objects and the room required around the fitting.
4. If in any doubt, consult a professional, taking local installation requirements into account. Some countries stipulate that lighting may be installed only by registered installers.
5. When replacing a lamp, wait for it to cool, for a minimum of 5 minutes.
6. Clean with a clean, dry cloth or brush, use no solvents or abrasives. Avoid dampness on all electrical components.
7. Take account of all available technical information.
8. If the external flexible cable or cord of this luminaire is damaged, it shall be exclusively replaced by the manufacturer or his service agent or a similar qualified person in order to avoid a hazard.

1x hanging lamp
(frame + power cord)

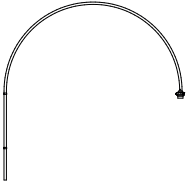

2x set wall brackets
+ spacers
(wall plugs included)

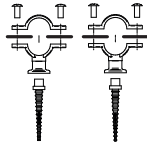

1x lamp shade

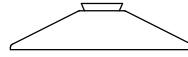

1x Led bulb silvered cap
4W - 350lm

2700 K (dimnable)
energy class A+



1. assemble these two parts of the back part

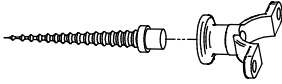

2. drill two holes with the requested diameter (\varnothing 10 mm) for the appropriate wall plugs according your type of wall

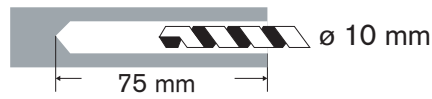
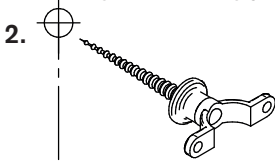

3. screw back part of wall bracket into the wall plug (by hand)

550 mm distance in between

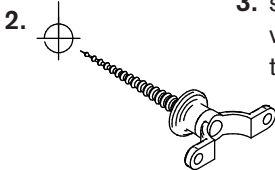

3. screw back part of wall bracket into the wall plug (by hand)

5. take care:

do not screw the wall brackets tight, in order to turn the hanging lamp

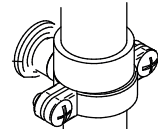

the ring rests on the upper wall bracket

4. screw carefully the frontpart of the wall bracket on the back part (by hand) make sure the spacers are in between

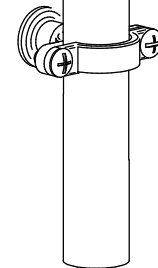
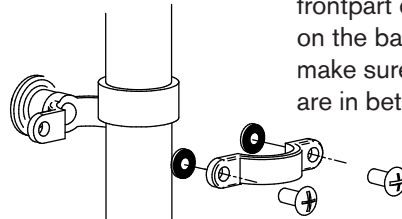

1.

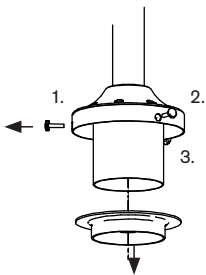

2.

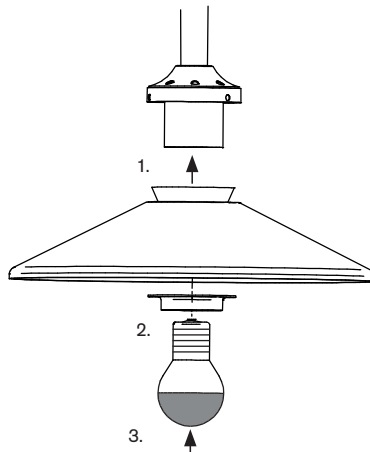

3.

