

a

by arturo alvarez

nevo collection

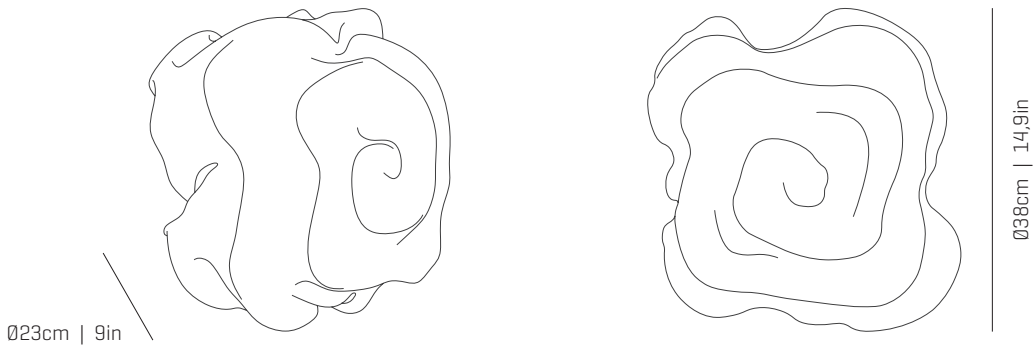

ref. NE06

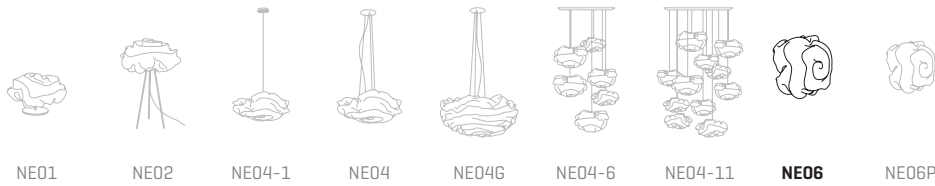

MATERIALS & COMPONENTS | MATERIALES & COMPONENTES

LAMP SHADE | TULIPA

Painted stainless steel | One color to choose
Acero inoxidable pintado | Un color a elegir

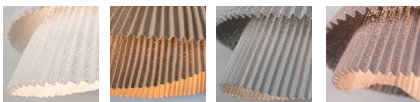

BL

BE

G

T

CUSTOM
COLOR

Steel gloss nickel-plated and stainless steel
Acero níquel-satinado y acero inoxidable

SUPPORT AND MOUNTING OPTIONS

SOPORTE Y OPCIONES DE INSTALACIÓN

Steel gloss nickel-plated and stainless steel
Acero níquel-satinado y acero inoxidable

Wall lamp
Aplicque

RECOMMENDED BULBS

BOMBILLAS RECOMENDADAS

230V - 50Hz

E14 LED Vintage - Max. 2x7 W

E14 LED Standard - Max. 2x7 W

120V - 60Hz

E12 LED - Max. 2x7 W

ENERGY EFFICIENCY

EFICIENCIA ENERGÉTICA

from A++ to E
desde A++ a E

OTHER DATA | OTROS DATOS

NET WEIGHT | PESO NETO

1,1kg | 2,4lb

PACKAGING | EMBALAJE

36x36x31cm | 14,2x 14,2x 12,2in

2,2kg | 4,8lb

ELECTRICAL FEATURES

CARACTERÍSTICAS ELÉCTRICAS



CERTIFICATIONS

CERTIFICACIONES



Nevo

ref. NE06

Suitable for indoor use, at 25°C

Apta para uso interior a temperatura ambiente de 25°C

Box contains | Contenido de la caja:

A - Lampshade | Tulipa [1]

B - Holding piece | Pieza de sujeción [1]

C - Security screws | Tornillos de seguridad [2]

E - Electrical disposal | Ficha [1]

F - Screws | Tornillos [2]

G - Wall Plugs | Tacos [2]

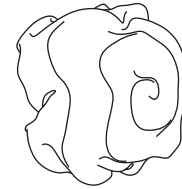

Recommended bulbs : E14 LED Vintage - Max. 2x7 W | E14 LED Standard - Max. 2x7W
Bombillas recomendadas : E14 LED Vintage - Max 2x7 W | E14 LED Standard - Max 2x7 W

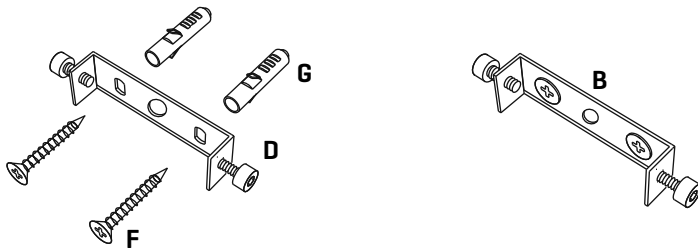

1

Drill the holes in the ceiling, fit the wall plugs into them and screw the holding piece.

Realizar los agujeros en el techo, colocar los tacos y atornillar la pieza de sujeción.

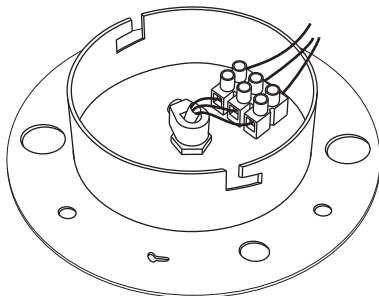

2

Pass the electric cables to the interior and do the electric connection.

Pasar los cables eléctricos al interior y hacer la conexión eléctrica dentro de la caja de conexiones.

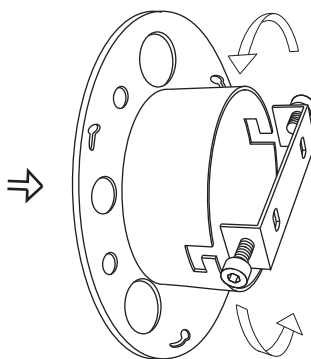

3

Insert the canopy in the holding piece and tight the security screws.

Encajar el florón en la pieza de sujeción y apretar los tornillos de seguridad.

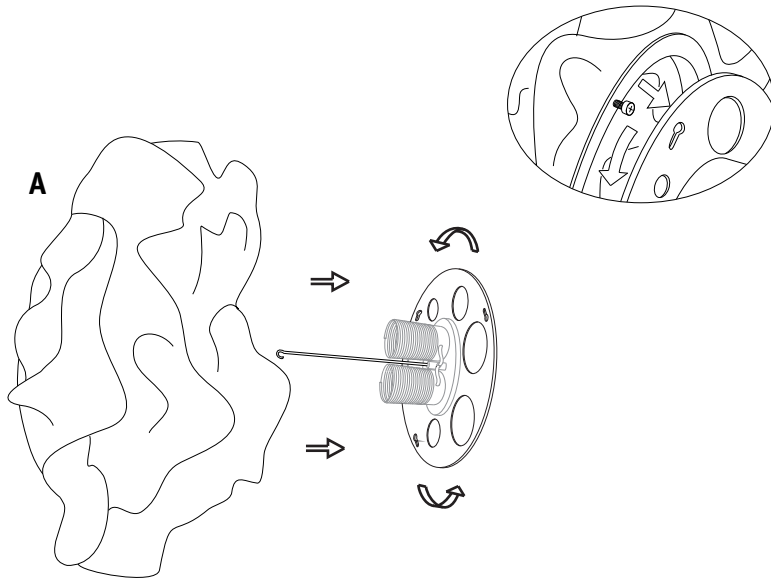

4

Fit the shade in the base, turn it until it reaches the end stop by inserting the fixing screws to the slots of the canopy. Tighten the fillet of the fixing screws to fasten the whole set.

Encajar la tulipa en el soporte, girándola hasta que haga tope al introducir los tornillos de enganche en las ranuras del florón. Apretar la rosca de los tornillos de enganche para asegurar el conjunto.



The device is not suitable for installation on normally inflammable surfaces.

Aparato no adaptado para la instalación en superficies normalmente inflamables.