

Portemanteau mural Wall coat rack

Ambroise

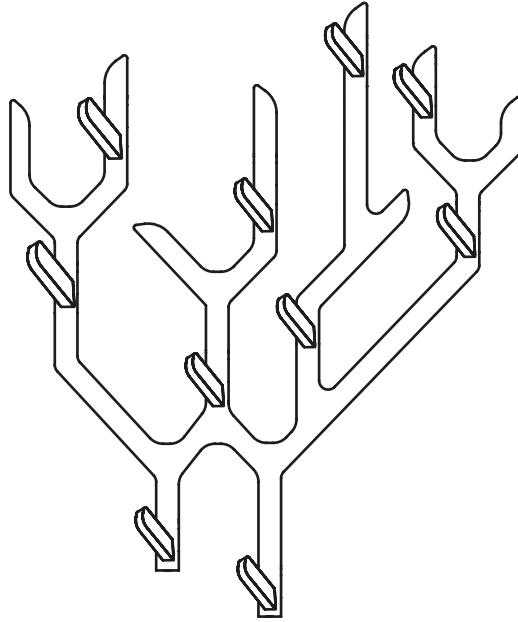

Design by Adeline Coulon



DANS VOTRE COLIS IN YOUR PACKAGE

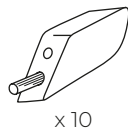
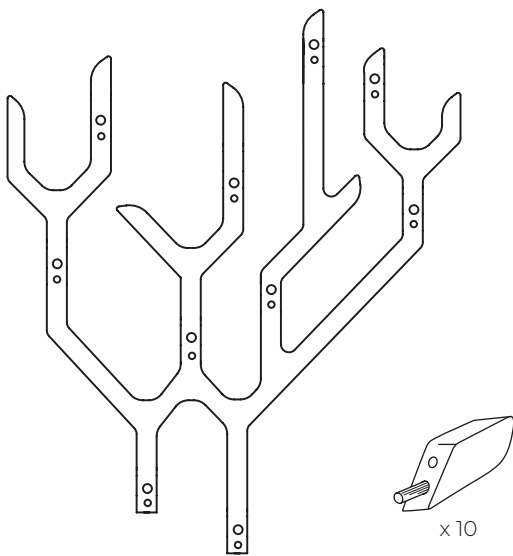

MATÉRIEL REQUIS REQUIRED TOOLS

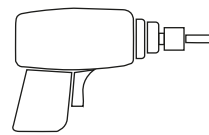

Perceuse - Visseuse
Drill - Screwer

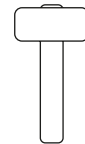

Maillet
Mallet



Chevilles + Vis
Wall plugs + Screws
x 2

À ASSEMBLER SEUL ASSEMBLE ON YOUR OWN



x1

Une question ? Contactez-nous grâce au formulaire dédié sur notre site !
 Have a question? Please contact us using the dedicated form on our website!

 www.hartodesign.com



FR
 Donnez ou recyclez vos meubles.



ou Association



ou Magasin



ou Déchèterie

<https://quefairedemesdechets.fr>

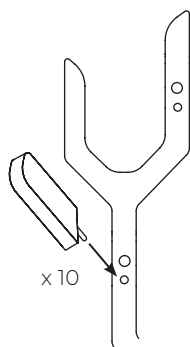

①

Installer les bras le long de la structure en insérant les tourillons dans les trous prévus à cet effet.

Place the arms along the structure by fitting them over the dowels.

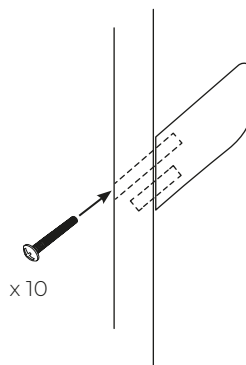

②

Fixer les bras à l'aide des vis fournies. Utiliser une visseuse pour plus de facilité.

Attach the arms with the screws provided. Use a screwdriver for ease of installation.

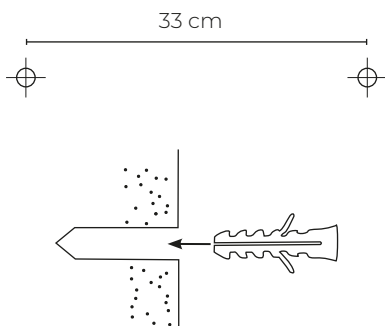

③

Percer le mur de 2 trous espacés de 33 cm. Insérer les chevilles adaptées au type de mur à l'aide du maillet.

Drill 2 holes spaced 33 cm apart in the wall. Insert the wall plugs best suited to the wall with the mallet.

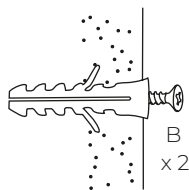

④

Visser une vis dans chaque cheville, tout en les laissant dépasser d'environ 5mm.

Screw one screw into each wall plug, leaving them protruding by about 5mm.

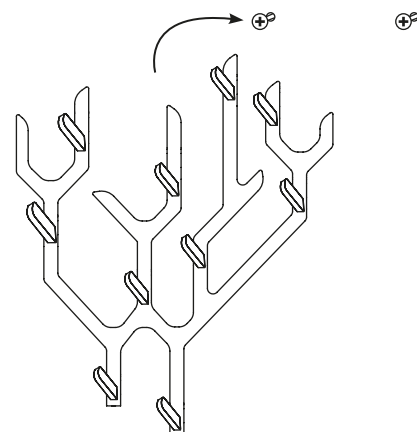

⑤

Installer le portemanteau en glissant les vis dans les encoches prévues sur l'arrière du portemanteau.

Hang the coat rail on the screws.