

Lampe à poser Table lamp

Nina

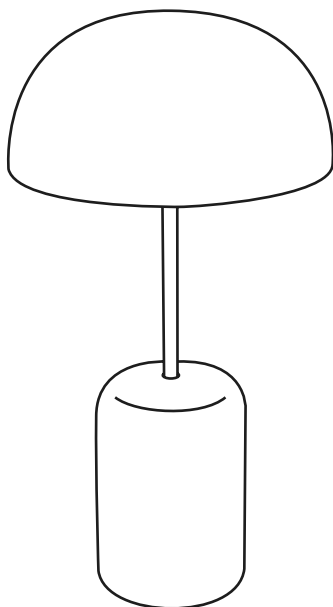

Design by **Tristan Lohner**



DANS VOTRE COLIS IN YOUR PACKAGE

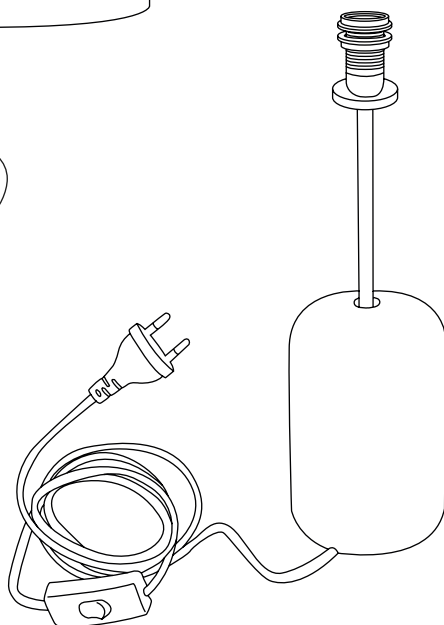
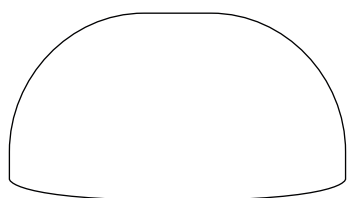

À ASSEMBLER SEUL ASSEMBLE ON YOUR OWN



x1

AMPOULE REMPLAÇABLE REPLAÇABLE BULB

- Douille / Socket : E14
- Puissance / Power : 40 W max
- Voltage : 220-240 V
- Frequence / Frequency : 50-60 Hz

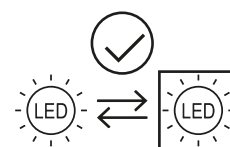

IP20



Une question ? Contactez-nous grâce au formulaire dédié sur notre site !
Have a question? Please contact us using the dedicated form on our website!



 www.hartodesign.com

Hartô - Orizon SAS, 7 rue Jean Elysée Dupuy
69410 Champagne au Mont d'Or - France

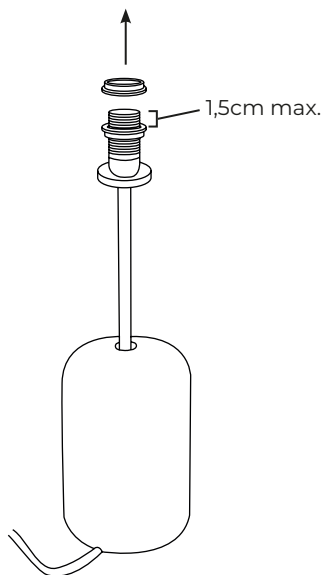

①

Dévisser la bague supérieure présente sur la douille. S'assurer que la bague inférieure est positionnée à environ 1,5cm max. du haut de la douille.

Unscrew the upper ring from the socket. Make sure the lower ring is positioned approximately 1.5 cm from the top of the socket.

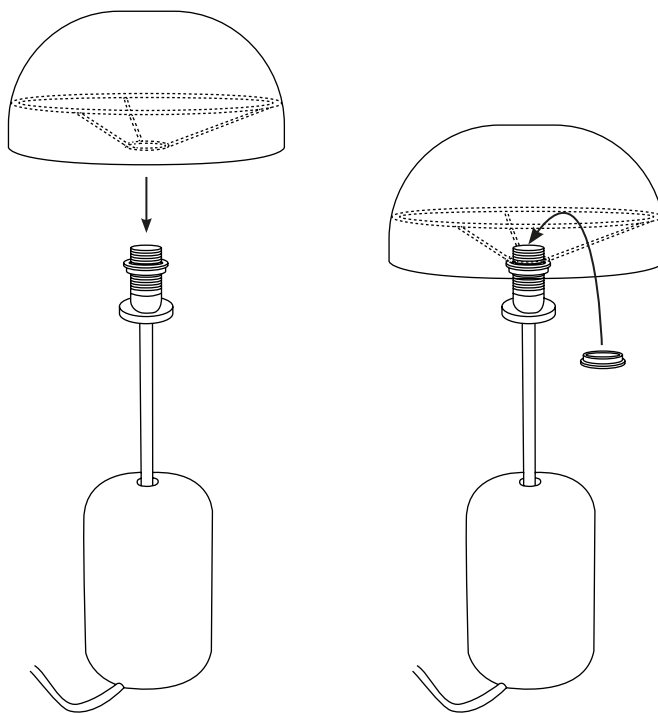

②

Insérer l'abat-jour sur la douille puis remettre en place la bague supérieure en la vissant bien pour bloquer l'abat-jour.

Place the lampshade onto the socket, then screw the upper ring back on tightly to secure the lampshade.

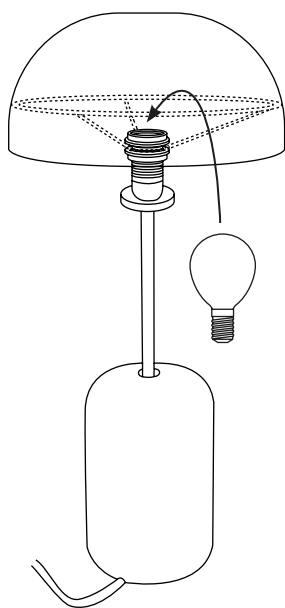

③

Mettre l'ampoule en place en la vissant dans la douille.

Screw the bulb into the socket.

