

Foscarini

MODULO E26.

Parete / Wall.

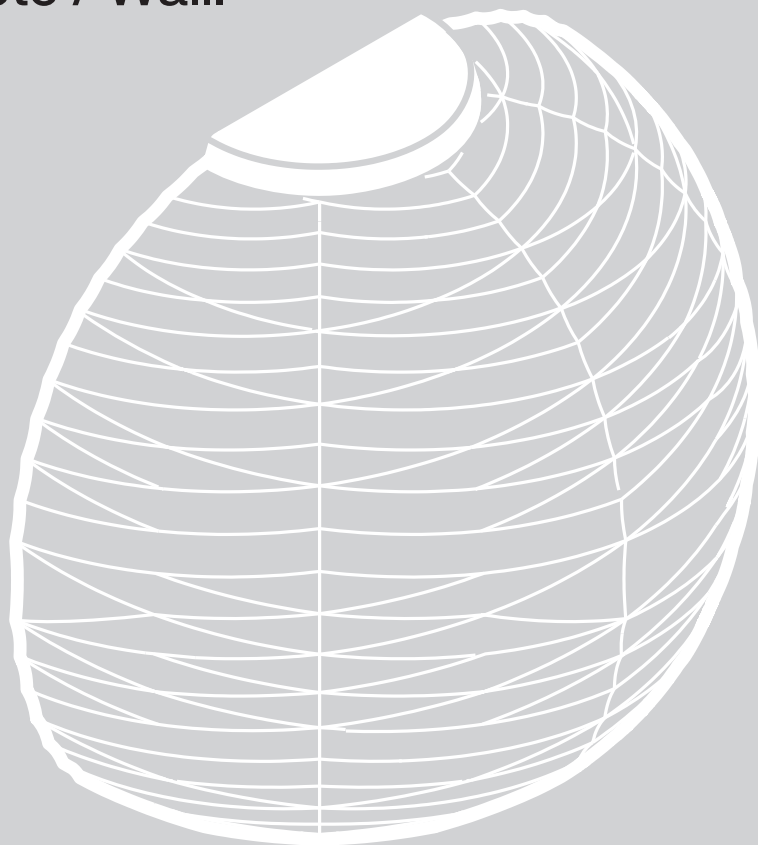

Istruzioni di montaggio
Assembly instructions

small Ø 3.94" x2

large Ø 5.51" x2

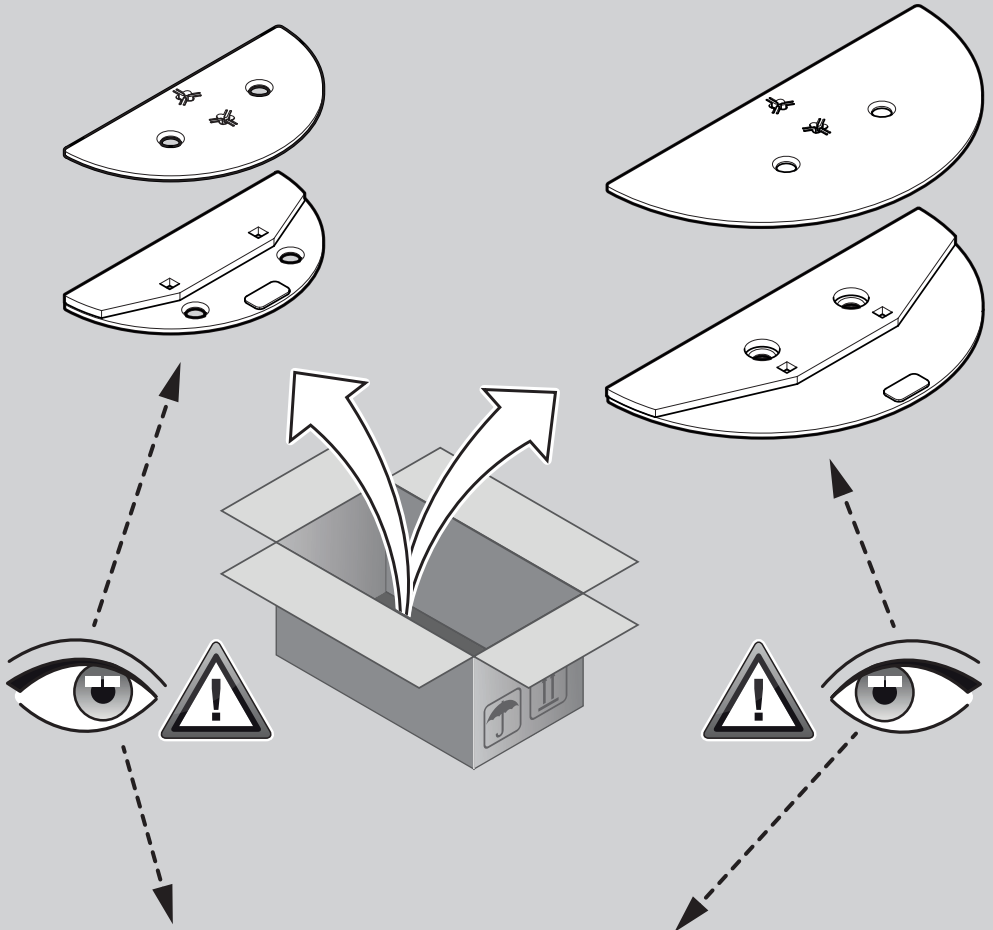

piccolo/small

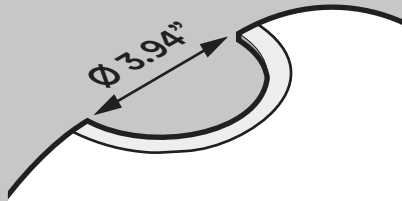

grande/large

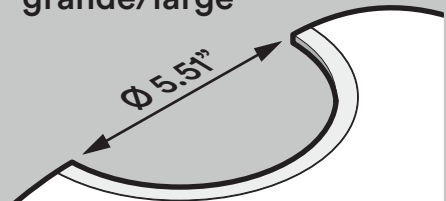

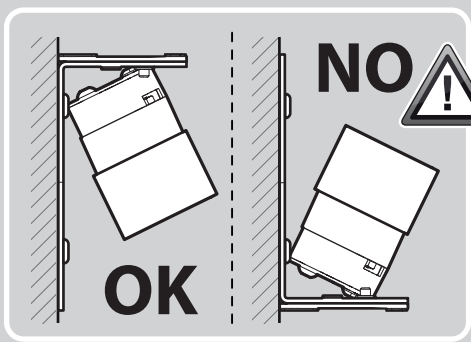
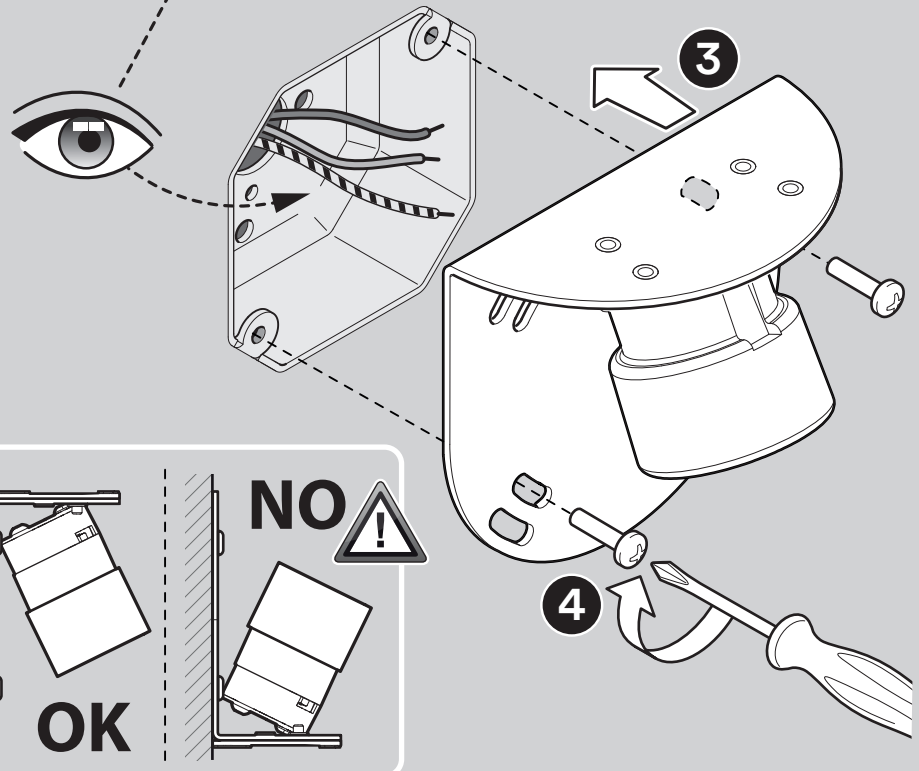
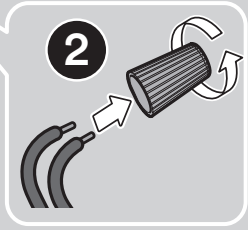
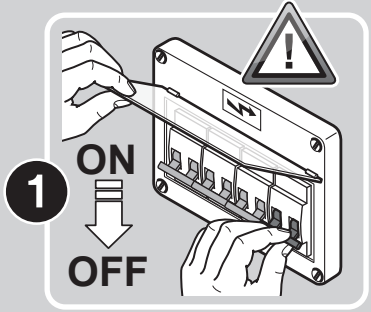
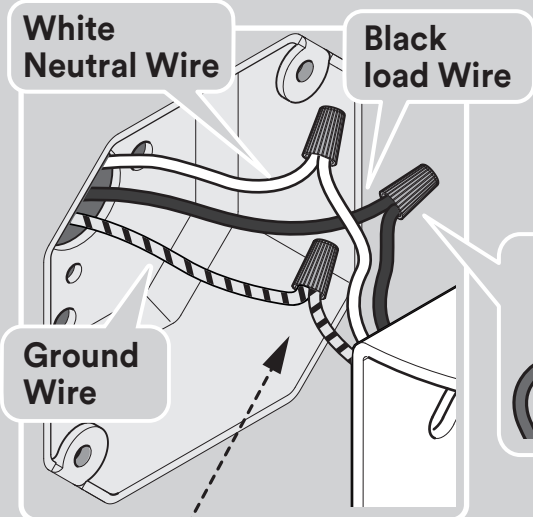

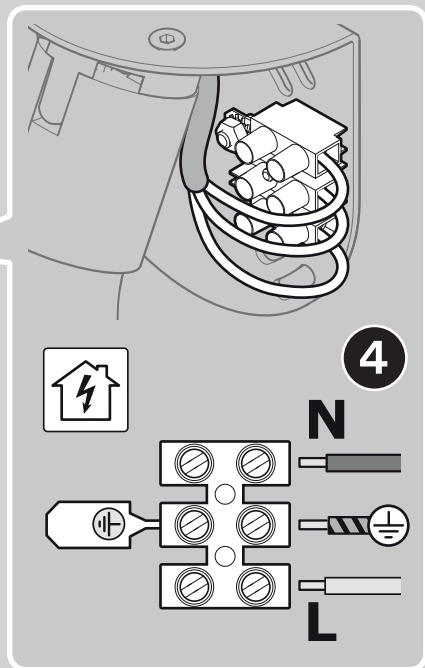
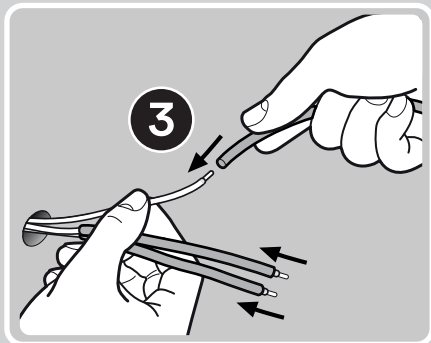
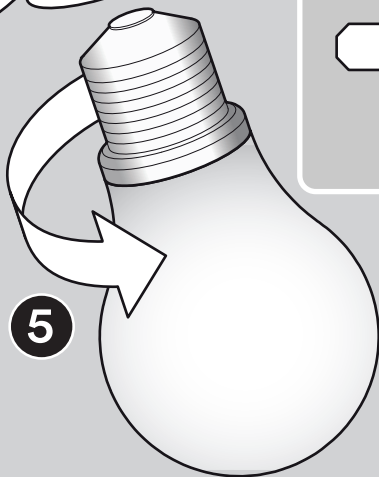
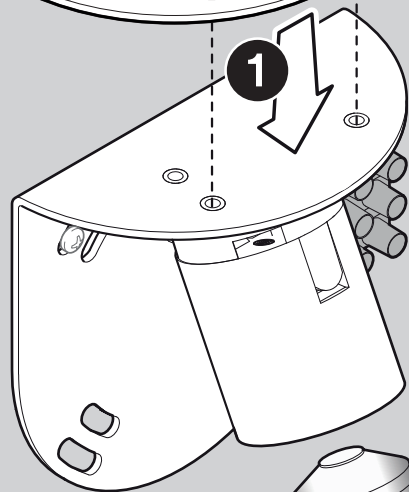
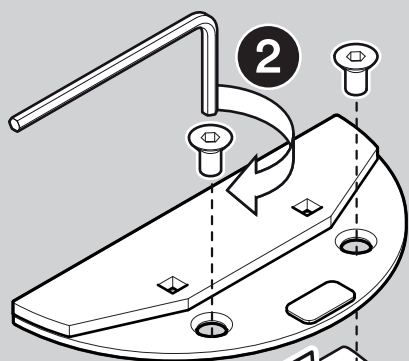



OK

NO

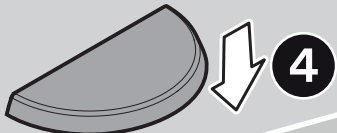

4

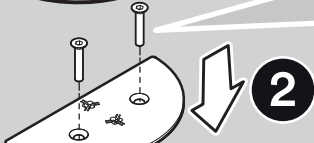

2



3

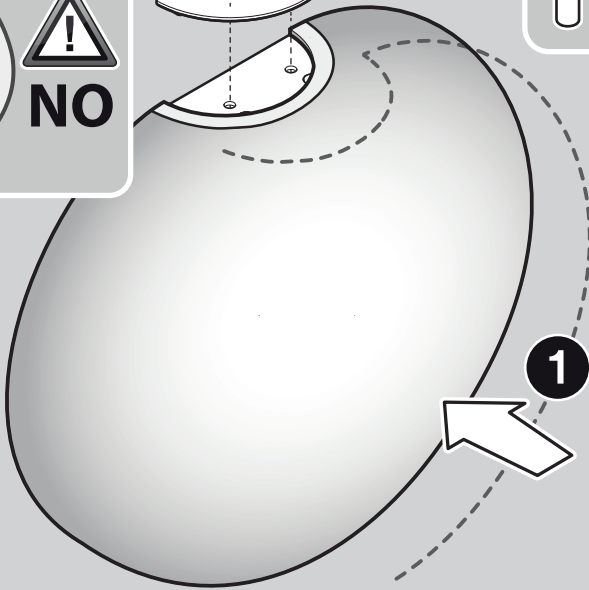

1

Chouchin Semi

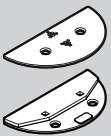

Ø 0.39"

Gem

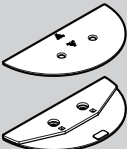
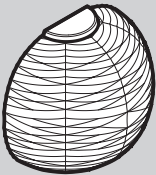

Ø 0.55"

Gregg



Grande/ Media

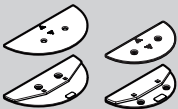

Ø 0.55" Ø 0.39"

Rituals 1

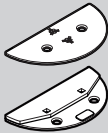
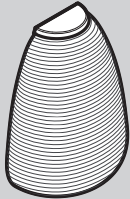

Ø 0.39"

Rituals 3

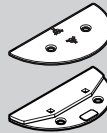
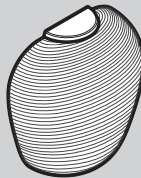

Ø 0.39"

Rituals XL

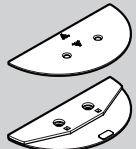
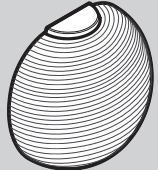

Ø 0.55"

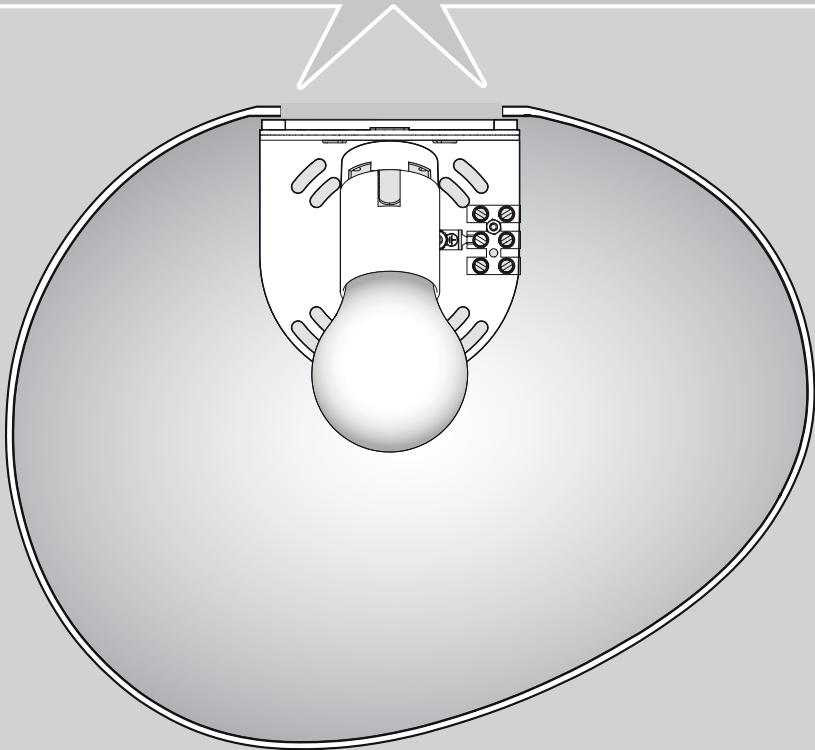
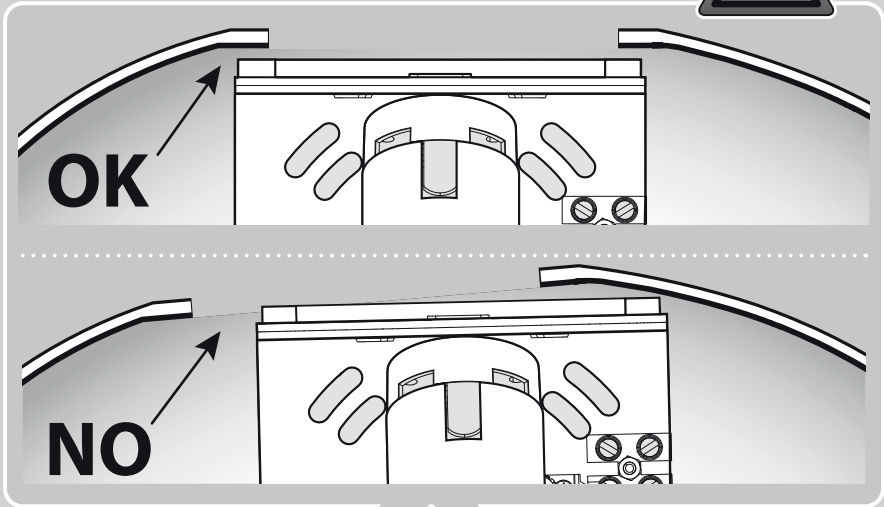

Modulo E26 parete, wall

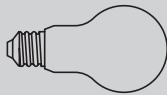

MAX 1x30W E26 120-277V ~ 60Hz



Chouchin Semi

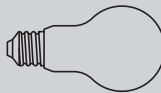

→ **Max Ø 0.39", H 0.39"**

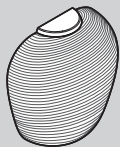

RITUALS 3

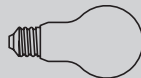

→ **Max Ø 1.77", H 3.03"**

EN → Warning

- The fitting has to be installed and maintained only by qualified staff.
- Always unplug the appliance from the power socket before beginning installation or any sort of maintenance work.
- The safety of this fixture is only guaranteed if the following instructions have been observed so they have to be kept you future reference.
- While the lamp is on and until it has cooled, there is a risk of burns from the lamp and adjacent elements.
- Assembly and maintenance of fixture must be performed carefully so as not to damage components.
- The luminaire must not be installed in any position other than that shown in the instructions.

FOSCARINI will replace merchandise with manufacturing defects only if it is returned to the retailer from which it was purchased and in any event only after assessing the defect. The luminaire may in no way be modified or tampered with; any modification may compromise safety causing the luminaire to become dangerous. FOSCARINI declines all responsibility for products that are modified.



Cleaning instructions: do not use alcohol or other solvents. Use only a soft cloth to clean the lamp, dampened with water and soap or mild cleanser if needed for resistant dirt.



The ETL Mark is proof of product compliance to North American safety standards. The ETL certification is issued by Intertek, an independent Third Party company for testing, inspection and certification.



This product is for indoor use only.

FR → Instructions

-L'installation et l'entretien de l'appareil doivent être faits exclusivement par du personnel qualifié.

-Avant de procéder à l'installation de l'appareil, ainsi qu'avant toute opération d'entretien, il est nécessaire de couper le courant au disjoncteur.

-La sûreté de l'appareil n'est garantie qu'en suivant scrupuleusement les instructions ci-après. Il est donc nécessaire de les conserver.

-Lorsque la lampe est allumée et jusqu'à son refroidissement après débranchement, il y a un risque de brûlure sur la lampe et les éléments proches.

-Le montage et les manipulations de l'appareil devront être exécutés avec la plus grande attention pour ne pas abîmer ses composants.

-La sustitución de la fuente de luz de esta lámpara podrá ser efectuada exclusivamente por parte del fabricante, de su servicio de asistencia o personal cualificado equivalente

FOSCARINI n'échangera ses articles défectueux que par l'intermédiaire d'un revendeur et de toute façon après avoir vérifié le défaut. L'appareil ne peut être modifié ou altéré de quelque manière que ce soit, toute modification peut compromettre la sécurité de celui-ci en le rendant dangereux. FOSCARINI décline toute responsabilité pour les produits modifiés.



Instructions pour le nettoyage : ne pas utiliser d'alcool ou solvants. Pour le nettoyage de la lampe utiliser exclusivement un chiffon doux, humecté si nécessaire, avec de l'eau et du savon ou avec un détergent neutre pour les salissures les plus tenaces.



La marque ETL atteste la conformité du produit aux normes de sécurité nord-américaines. La certification ETL est délivrée par Intertek, une société tierce indépendante pour les tests, l'inspection et la certification.



Cet appareil doit être utilisé uniquement en intérieur.

ES → Advertencias

- La instalación y mantenimiento del aparato deben realizarse por un profesional.
- Antes de proceder a la instalación del aparato y en cualquier caso antes de efectuar cualquier operación de mantenimiento, corte la tensión de red.
- La seguridad del aparato está garantizada sólo con el uso de las instrucciones siguientes, por lo tanto es necesario atenderlas puntualmente.
- Cuando el dispositivo está encendido, o durante el enfriamiento posterior al apagado, la fuente de luz y las partes adyacentes pueden provocar quemaduras.
- Las operaciones de montaje o manutención del aparato deben seguirse con la máxima atención para no dañar los componentes.
- El aparato no debe ser instalado en distinta posición de aquella que se indica en las instrucciones de montaje.

FOSCARINI no podrá proceder a la sustitución de sus artículos por defectos de la fabricación, si non vienen tramitados a través del punto de venta. El aparato no puede ser en ningún caso modificado o forzado, cualquier modificación puede comprometer la seguridad haciéndolo peligroso.

FOSCARINI declina cualquier responsabilidad por los productos modificados.



Instrucciones para limpiar la lámpara : no emplear alcohol ni disolventes. Para la limpieza de la lámpara, utilizar exclusivamente un paño suave. En caso de suciedad más resistente, humedecer el paño con agua y jabón o un detergente neutro.



El marcado ETL certifica el cumplimiento del producto con las normas de seguridad de América del Norte. La certificación ETL es emitida por Intertek, una empresa independiente para pruebas, inspección y certificación.



Este producto es para uso en interiores solamente.

FOSCARINI

Foscarini SpA
via delle Industrie 27
30020 Marcon / Venezia / Italy
T +39 041 595 3811
foscarini@foscarini.com

Foscarini Spazio Monforte
Corso Monforte 19
20122 / Milano / Italy
T +39 02 870 71320
spaziomonforte@foscarini.com

Foscarini Inc / Foscarini Spazio Soho
20 Greene Street, New York
NY / 10013 / USA
T +1 212 247 2218
T +1 212 257 4412 | Showroom
foscarini.inc@foscarini.com
spaziosoho@foscarini.com

Foscarini Japan K.K.
Tokyo / Japan
foscarini.jpn@foscarini.com

Foscarini International Co., Ltd.
Shanghai, China
foscarini.china@foscarini.com

Azienda certificata
UNI EN ISO 9001
UNI EN ISO 14001

Follow us:



foscarini.com