

## Instructions



# P376 KF1 Kastholm & Fabricius 1963

---

Congratulations with your new P376 lamp, designed in 1963 by Kastholm & Fabricius. We hope you will enjoy using this lamp and follow these instructions to ensure correct installation. If you have any questions or comments, please do not hesitate to contact us by mail on:

[info@andtradition.com](mailto:info@andtradition.com)

# P376 KF1

## Kastholm & Fabricius

### 1963

Please read these instructions carefully and retain them for future reference to ensure that the product is used correctly. For your own safety, please study each step of this instruction manual first. &Tradition is not responsible for any faults or damages caused by not following these instructions correctly. Do not modify this product in any way.

#### Contents

- A Lamp shade
- B Lamp holder unit with cable
- C Canopy with metal ceiling bracket and connection box
- D Connection box

#### Tools needed

- Bulb type E27
- Small flat-head screwdriver for wiring

#### Safety precautions

- Dispose of all plastic bags from the packaging and do not allow children to play with it.
- Keep the product well out of children's reach.
- The lamp is only intended for interior use.
- Consult a professionally qualified electrician if in any doubt.
- Disconnect the electricity supply at the fuse box, before commencing work

#### Cleaning instructions

- Wipe the surface of the lamp shade with a soft, damp sponge or cloth, and wipe immediately after with a dry cloth.
- Do not use any abrasive cleaning tools such as steel wool, scouring sponges or stiff brushes.
- Never use strong cleaning agents such as white spirit, turpentine, household glass cleaner or cellulose thinners.

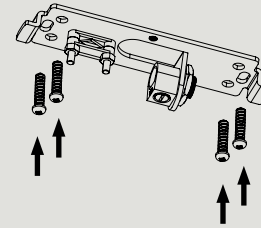
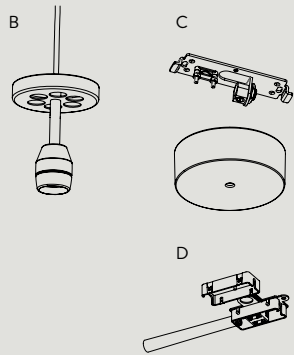
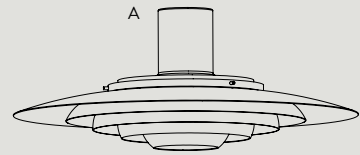

#### Step 1

Ensure power supply is turned off and remove any existing lamp fitting. Locate the supply cable and ensure it is ready to be fitted to the connector box.

Mount the metal bracket (C) securely in the ceiling with screws and wall plugs, appropriate for the ceiling of installation.

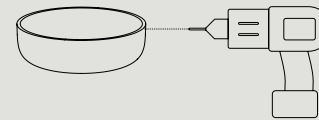

#### Step 2

Drill a hole into the side of the canopy and pull electric cord through it

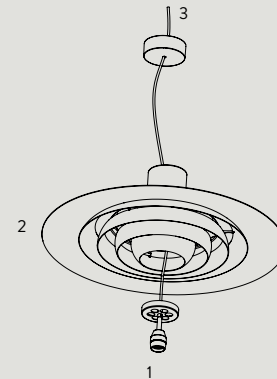

#### Step 3

Pull the cable from the lamp holder unit (1) through the lamp shade (2) and the canopy cup (3).

Make sure the lamp holder unit goes all the way to the top inside the shade.

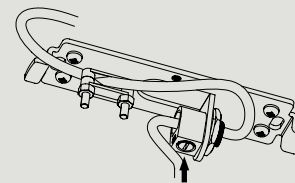

#### Step 4

To determine the right suspension height for the lamp, pass the electrical cord through the strain relief of the metal bracket (C). When you have the desired suspension height of the lamp, tighten the plastic screw of the strain relief.

For indoor use only  
E27 maximum 100W  
Bulb not included

### Step 5

Use the terminal box inside the connection box (D) to assemble the wires from the pendant with the wires from the power supply. Close the connection box and place it inside the canopy.

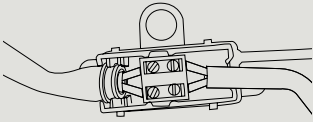

### Step 6

Install the plastic canopy onto the metal bracket.

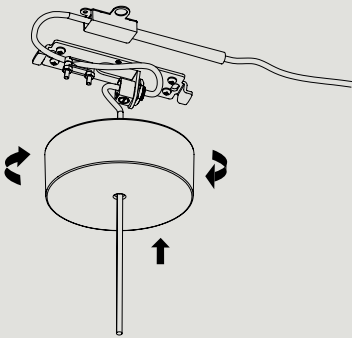

### Step 7

Install the light bulb.

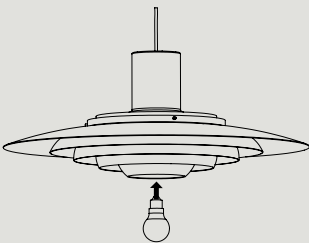

&Tradition®