

Please read carefully and save these instructions, as you may need them at a later date for bulb replacement, cleaning or maintenance.

The product meets the following standards: IEC/EN 62031, IEC/EN 61000-3-2, EN 60598-2-1:1997

The glass is hand made, each piece is unique. Tiny bubbles and optical irregularities may occur and are considered a proof of its handmade origin.

SAFETY

BE SURE THE ELECTRICITY TO THE WIRES YOU ARE WORKING ON IS SHUT OFF. EITHER THE FUSE IS REMOVED OR THE CIRCUIT BREAKER IS TURNED OFF. TURNING THE POWER OFF USING THE LIGHT SWITCH IS NOT SUFFICIENT TO PREVENT ELECTRICAL SHOCK.

ASSEMBLY AND INSTALLATION

Check the contents to be sure everything is included. Before starting the installation, disconnect the power by turning off the circuit breaker or by removing the appropriate fuse at the fuse box. Turning the power off using the light switch is not sufficient to prevent electrical shock.

All electrical connections must be in accordance with local standards. Installation of the fixtures should only be done by an authorized electrician in accordance with the installation instructions and sector specific safety requirements. Any repairs of service and maintenance must be done by a person with the appropriate qualifications and who has read these guidelines. Any work carried out on the lighting fixtures should be performed only when the circuit is disconnected. During service and maintenance or remedial work, care should be taken to examine the mechanical status of the fixture fixings. It is prohibited to install the fixture to any light sources other than those specified on the product label. Failure to comply with this may result in product failure, jeopardize the electrical the electrical installation, or pose a risk to health and safety.

IT IS FORBIDDEN TO:

- Install the lighting fixtures to a power supply outside the parameters specified on the product label.
- Install the lighting fixtures in environments inconsistent with the stated degree of ingress protection (IP rating).
- Install the lighting fixtures with distance smaller to the illuminated object than specified on the product label.
- Install the lighting fixtures on a surface or structure other than is recommended by the manufacturer.
- Apply either mechanical elements or adapt the electrical installation procedure other than included in the instruction for use manual. Painted surfaces should always be cleaned with a soft damp cloth with the power disconnected. It is inadvisable to use chemically aggressive or solvent based cleaning agents. On culmination of their commercial life, the lighting fixtures should not be haphazardly discarded. They must be disposed of according to the WEEE Directive regulations - either to a waste disposal point or returned to the manufacturer.

Failure to comply with the above might result in product failure, jeopardize the electrical installation, or pose a risk to health and safety.

CLEANING AND MAINTENANCE

Polish using soft cloth.
Never use abrasive chemicals or materials.
To clean the glass shade use suitable glass cleaner.
Always use fabric gloves to protect the surface against damage.

NOTE

The important safeguards and instructions appearing in this manual are not meant to cover all possible conditions or situations that may occur. It must be understood that common sense, caution, and care, are factors which cannot be built into any product. These factors must be supplied by the person(s) installing this unit.

DECHEM

STRATOS LIGHT ceiling

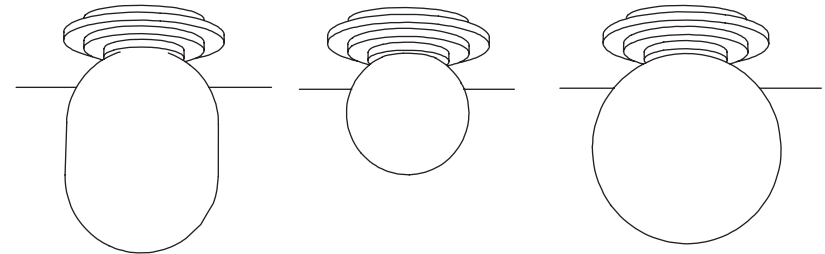

LED chip 6 W, 230 V 50 Hz
IP 20
CLASS I

DIMENSIONS
ball small 12 x 14 cm, ball big 18 x 20 cm
capsule small 15 x 22 cm

Make sure to read these installation instructions and review the diagrams thoroughly before installation.

STEP BY STEP INSTALLATION

MAKE SURE ALL THE ELECTRICAL POWER IS OFF

ASSEMBLING THE LIGHT

A

Unscrew the securing nuts (1) using the hex key (not part of the delivery) and remove the back wall cap (2).

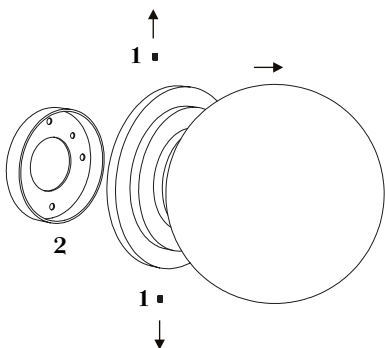

B

Introduce the wall electric cable using the central hole (3) and the rear hole (4) asymmetrically positioned on the metal wall cap (2) for grounded wire.

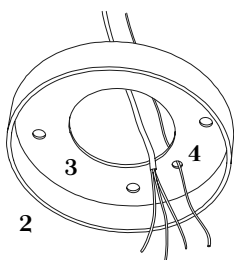

C

Fix the wall cap (2) to the wall using four screws (not part of the delivery) according to the wall material.

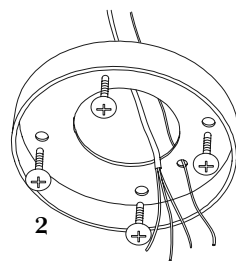

D

Connect the wires respecting the colours: L is brown or black, N is blue, grounded wire is green/yellow.

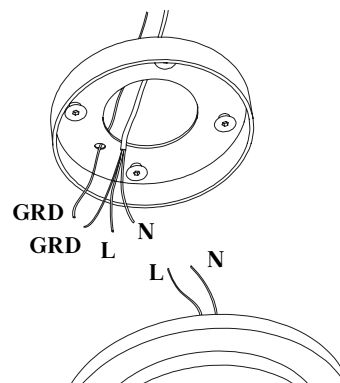

E

Put back the metal light fixture (2) and tighten with the two securing nuts (1).

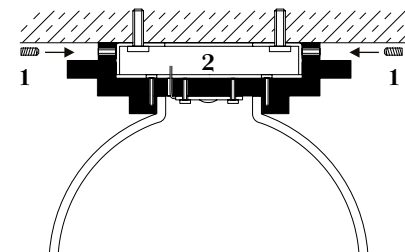

LED CHIP REPLACEMENT

A

Unscrew the two screws (1) on the backside of the metal light fixture and remove the glass lampshade.

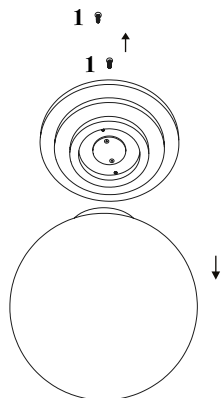

B

Unscrew the two screws (2) on the LED chip (3) using the hex key (not part of the delivery) and replace the chip itself by reconnecting of the wires.

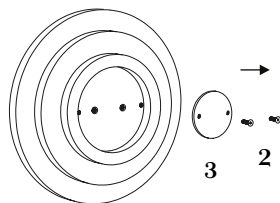

GLASS REPLACEMENT

C

Unscrew the three nuts (4) on the sleeve ring (5) using the hex key (not part of the delivery) and remove the glass lampshade.

