

# Tacoma Single Grande

astro

## General

Location:	Bathroom/Interior
Class:	CE (Class I)
Ip Rating:	IP44
Bathroom Zone:	Zone 2, 3
Driver Required:	No
Installation Orientation:	Wall Mount - Vertical
Main Material:	Metal - Zinc
Dimensions (mm):	H: 450 W: 70 D: 135
Cut Out Hole :	-
Recess Depth (mm):	-
Fire Rating:	-
Cable Length (mm):	-
Gross Weight (kg):	0.96

## Lamp

Light Source:	G9
Wattage:	3.5W Max
Lamp Included:	No
Maximum Lamp Length (mm):	60
Luminous Flux (lm):	Lamp Dependent
Colour Temp (K):	Lamp Dependent
Cri (Ra):	Lamp Dependent
Macadam Ellipse:	Lamp Dependent
Tilt Adjustable Angle (°):	-
Rotation Adjustable Angle (°):	-
Lifetime (hrs):	Lamp Dependent
Beam Angle (°):	-

## Electrical

Switched:	No
Dimmable:	Yes
Dimming Method:	Lamp Dependent
Supply Frequency (Hz):	-
Driver/Ballast Voltage (V):	-
Driver Lifetime (hrs):	-
Efficacy (lm/W):	Lamp Dependent

## Additional Information:

Shade Included:	Shade Sold Separately
Shade/Diffuser Material:	-
Shade/Diffuser Finish:	-
F Mark:	Not suitable for mounting on flammable materials

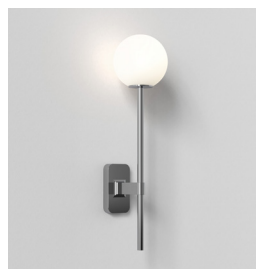

CODE: 1429003  
FINISH: POLISHED CHROME

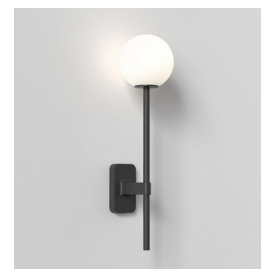

CODE: 1429006  
FINISH: MATT BLACK

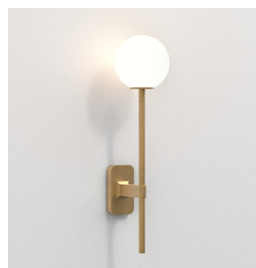

CODE: 1429009  
FINISH: ANTIQUE BRASS

To maintain this product to its best condition, please view our care and cleaning guide on the support section of the astro website.

Pour entretenir au mieux ce produit, veuillez consulter notre guide d'entretien et de nettoyage, dans la rubrique d'aide sur le site Web d'Astro.

Um dieses Produkt im besten Zustand zu erhalten, beachten Sie bitte unseren Leitfaden zu Pflege und Reinigung im Abschnitt „Support“ auf der Astro-Website.

Per mantenere questo prodotto nelle sue migliori condizioni, consultare la nostra guida per la manutenzione e la pulizia nella sezione dedicata all'assistenza del sito Web Astro.

# Product Elevations

astro

Without Shade

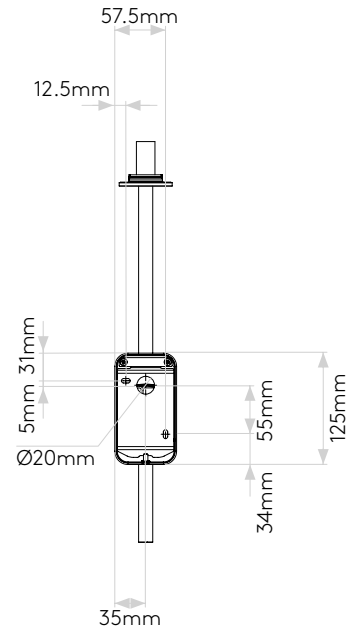
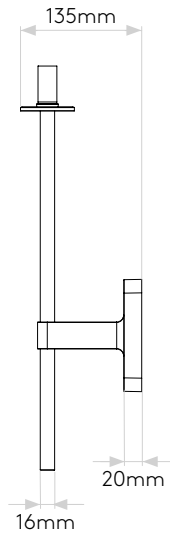
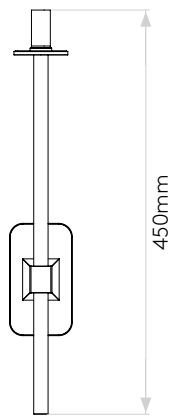
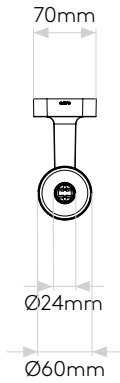

With Tacoma Shade

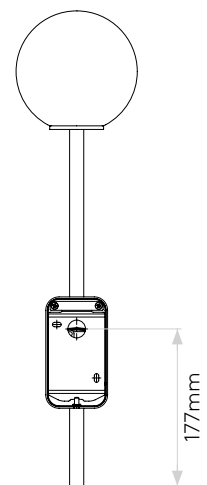
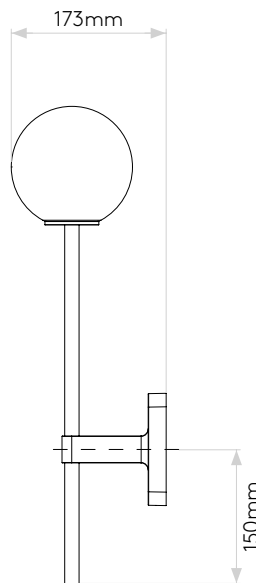
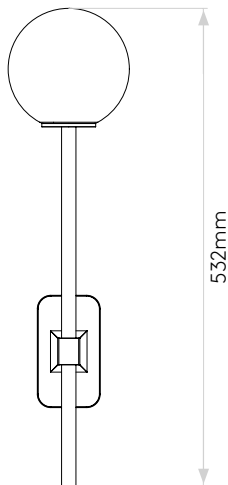
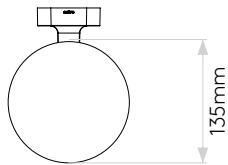

Please note that some dimensions may vary slightly due to manufacturing tolerances, this includes cable entry and fixing holes

Veuillez noter que certaines dimensions peuvent varier légèrement en raison des tolérances de fabrication, y compris l'entrée de câble et les trous de fixation.

Bitte beachten Sie, dass die Maße Fertigungstoleranzen unterliegen und daher in geringem Umfang von der angegebenen Größe abweichen können. Dies gilt auch für Kabeingänge und Befestigungslöcher.

Si prega notare che possono esserci piccole variazioni in alcune dimensioni dovute alle tolleranze di produzione, queste includono l'ingresso del cavo e i fori di fissaggio.