

**CLIC POST
CLIC POST UP
LED**
ø40 - ø60

3c

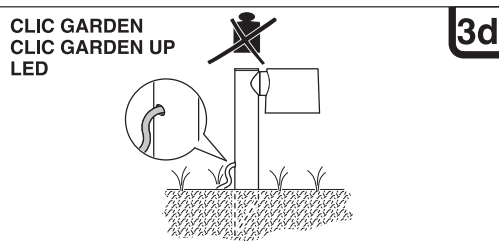

**CLIC GARDEN
CLIC GARDEN UP
LED**

3d

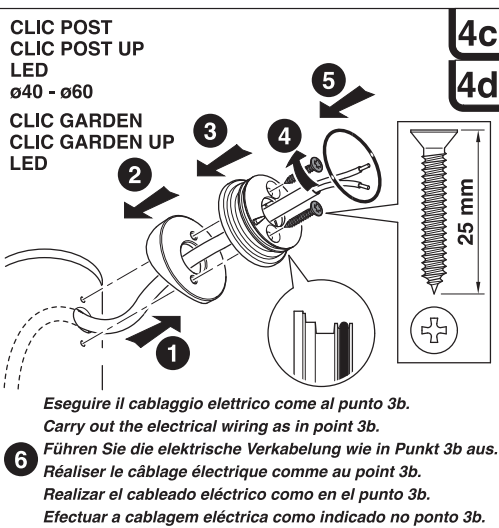

**CLIC POST
CLIC POST UP
LED**
ø40 - ø60

4c

**CLIC GARDEN
CLIC GARDEN UP
LED**

4d

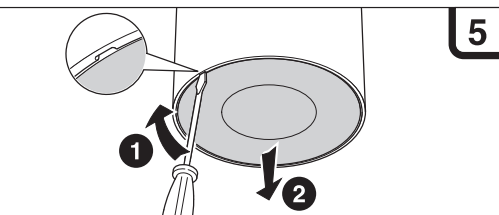

5

I **ATTENZIONE!** La sicurezza dell'apparecchio è garantita solo con l'uso appropriato delle seguenti istruzioni, pertanto è necessario conservarle. La manutenzione e l'installazione devono essere eseguite solo dopo aver disinserito l'energia elettrica. Durante le fasi d'installazione evitare in qualsiasi caso l'utilizzo di sostanze lubrificanti quali oli, grassi o loro derivati; tali sostanze a contatto con le parti plastiche potrebbero causarne la rottura. L'apparecchio non deve, in alcuna circostanza, essere coperto con materiale isolante o similari. Il diffusore pulito garantisce il rendimento ottimale dell'apparecchio. Consigliamo una pulizia periodica utilizzando, per i diffusori in materiale termoplastico, detergenti neutri privi di silicone e suoi derivati.

A **Attenzione, rischio di scossa elettrica.** Alimentazione 220-240V. La sorgente luminosa contenuta in questo apparecchio deve essere sostituita esclusivamente con componenti originali e solo dal costruttore o dal suo servizio di assistenza o da personale altrettanto qualificato. Per i componenti di ricambio contattare il servizio assistenza Lombardo S.r.l. Questo prodotto contiene una sorgente luminosa di classe di efficienza energetica D.

Fra le diverse soluzioni a led è possibile rilevare una variazione della temperatura colore, in funzione della tecnologia costruttiva del led stesso. Tra diversi lotti di fornitura si ritiene accettabile una tolleranza del 15% sulla temperatura colore dei led.

LOMBARDO S.r.l. non risponde di danni a cose e persone imputabili a modifiche, manomissioni o impiego non conforme alle caratteristiche tecniche del prodotto.

Apparecchio totalmente protetto contro la polvere: IP 6X
Apparecchio protetto contro i getti d'acqua: IP X5
Classe I. Led 5W. IP 65

UK CAUTION! The safety of the light fitting is only guaranteed if the instructions are followed carefully and they must be kept for future reference. Maintenance and installation procedures must only be carried out when the mains have been switched off. During installation, avoid all use of lubricants such as oil, grease or any derivatives; such substances may cause damage to the plastic parts when in contact with them. The light fitting must never, under any circumstances, be covered with insulating or similar materials. A clean diffuser guarantees maximum light from the appliance. Periodic cleaning is recommended. For diffusers made of thermoplastic material, use neutral detergents that do not contain silicone or its derivatives.

A **Warning, electric shock hazard.** Power 220-240V. The light source contained in this device must only be replaced with original components and only by the manufacturer, its support service or similarly qualified personnel. For replacement parts please contact the After Sale Service of Lombardo S.r.l. This product contains a Class D energy efficiency light source.

Among the different led solutions, it is possible to detect a change in colour temperature, depending on the construction technology of the led. Among the different lots of supply a tolerance of 15% shall be acceptable on the colour temperature of the leds.

LOMBARDO S.r.l. is not liable for damage to property and people due to modification, tampering and use not in conformity with the technical characteristics of the product.

Light fitting totally protected from dust: IP 6X
Light fitting protected against jets of water: IP X5
Class I. Led 5W. IP 65

D ACHTUNG! Die Sicherheit des Gerätes ist nur bei Anwendung der folgenden Anweisungen gewährleistet, die daher aufbewahrt werden müssen. Arbeiten zur Wartung und Installation dürfen nur nach Unterbrechung der Stromzufuhr ausgeführt werden. Während der Installationsphase ist jeglicher Gebrauch von Schmiermitteln wie Öl, Fett und Folgeprodukte zu vermeiden, diese Stoffe können zu Schäden an den Plastikteilen führen. Das Gerät darf nie mit Isoliermaterial oder ähnlichem bedeckt werden. Eine gut gereinigte Abdeckung garantiert eine optimale Leistung des Apparats. Wir empfehlen daher, für die Abdeckungen aus thermoplastischem Material eine periodische Reinigung mit neutralen Reinigungsmitteln ohne Silikon oder Silikonderivaten.

A **Achtung, Gefahr eines elektrischen Schlags.** 220-240V Stromversorgung. Die in dieser Leuchte enthaltene Lichtquelle darf nur durch Originalteile und nur durch den Hersteller oder seinen Kundendienst oder gleich qualifiziertes Personal ersetzt werden. Für Ersatzteile bitte kontaktieren Sie den Kundenservice Lombardo S.r.l. Dieses Produkt enthält eine Lichtquelle der Energieeffizienzklasse D.

Unter den verschiedenen Led-Lösungen, je nach Konstruktion der Led-Technologie, kann eine Änderung der Farbtemperatur detektiert werden. Zwischen den verschiedenen Lieferungen gilt eine Toleranz von 15% auf die Led-Farbtemperatur.

LOMBARDO S.r.l. übernimmt keine Verantwortung für Schäden, an Sachen oder Personen, herbeigeführt durch unsachgemäße oder veränderte Handhabung oder Benutzung des Produktes.

Gerät vollständig staubgeschützt: IP 6X
Gerät Druckwasserstrahl geschützt: IP X5
Klasse I. Led 5W. IP 65

F **ATTENTION!** La sécurité de l'appareil n'est garantie qu'en cas d'emploi approprié des instructions suivantes. Nous vous conseillons donc de bien les conserver. L'entretien et l'installation ne doivent être effectués que lorsque le courant électrique est coupé. Pendant les phases d'installation, éviter l'usage de lubrifiants, comme par exemple huile, gras et dérivés, parce que ces substances pourraient détériorer les parties en plastique. L'appareil ne doit en aucun cas être recouvert par du matériel isolant ou similaire. Un diffuseur bien propre peut garantir un maximum de rendement. Nous vous conseillons donc de nettoyer l'appareil périodiquement à l'aide de détergents neutres sans silicone et dérivés pour les diffuseurs en matière thermoplastique.

A **Attention, risque de choc électrique.** Alimentation électrique 220-240V. La source lumineuse contenue dans cet appareil doit être remplacée par des pièces d'origine et uniquement par le fabricant, son service d'assistance ou par un personnel de qualification similaire. Pour les pièces de rechange contacter le service après vente Lombardo S.r.l. Ce produit contient une source lumineuse de classe d'efficacité énergétique D.

Parmi les différentes solutions, il est possible de détecter un changement de température couleur, en fonction de la technologie de construction de la led. Entre les différents lots de livraison on peut accepter une tolérance de 15% sur la température couleur des leds.

LOMBARDO S.r.l. n'est pas responsable des dommages aux biens et aux personnes en raison de modifications, manipulations ou utilisation non conforme aux caractéristiques techniques du produit.

Appareil totalement protégé contre toute infiltration de poussière: IP 6X
Appareil protégé contre les jets d'eau de toutes directions: IP X5
Classe I. Led 5W. IP 65

E **¡ATENCIÓN!** La seguridad del aparato está garantizada solamente con el uso apropiado de las siguientes instrucciones, por lo tanto es necesario conservárselas. El mantenimiento y la instalación deben ser efectuados sólo después de haber desconectado la energía eléctrica. Durante las fases de instalación evitar en todos los casos el uso de substancias lubricantes como aceites, grasas o sus derivados; dichas substancias en contacto con las partes de plástico podrían causar su rotura. El aparato no debe, en ningún caso, cubrirse con material aislante o similares. El difusor limpio garantiza un óptimo rendimiento del aparato. Aconsejamos una limpieza periódica utilizando, para los difusores de material termoplástico, detergentes neutros que no contengan siliconas y sus derivados.

A **Atención, riesgo de descarga eléctrica.** Alimentación 220-240 V. La fuente de luz contenida en este dispositivo debe ser sustituida exclusivamente con componentes originales por el fabricante, por su servicio de asistencia o por personal debidamente cualificado. Para los componentes de recambio contacte el servicio de asistencia Lombardo S.r.l. Este producto contiene una fuente de luz de clase de eficiencia energética D.

Entre las diversas soluciones de los leds, se puede detectar un cambio de temperatura color, dependiendo de la tecnología de construcción del led. Entre los diferentes lotes de la oferta se aceptará una tolerancia del 15% sobre la temperatura color de los leds.

LOMBARDO S.r.l. no se hace responsable por los daños a la propiedad y las personas debido a modificación, manipulación y uso no conforme a las características técnicas del producto.

Aparato con protección total frente al polvo: IP 6X
Aparato con protección contra chorros de agua: IP X5
Clase I. Led 5W. IP 65

P **¡ATENÇÃO!** A segurança do aparelho só é garantida se forem cumpridas as seguintes instruções, portanto será necessário conservá-las. A manutenção e a instalação devem ser feitas só após ter desligado a energia elétrica. Durante as fases de instalação evitar, em todo o caso, a utilização de substâncias lubrificantes tais como óleos, gorduras ou derivados; estas substâncias em contacto com as partes plásticas poderão causar a sua ruptura. O aparelho não deve, de maneira nenhuma, ser coberto com material isolante ou similares. O difusor limpo garante um óptimo rendimento do aparelho. Aconselhamos uma limpeza periódica utilizando, para os difusores de material termoplástico, detergentes neutros sem silicone e derivados.

A **Atenção, risco de choque elétrico.** Alimentação 220-240V. A fonte luminosa contida neste aparelho deve ser substituída apenas por componentes originais e apenas pelo fabricante ou pelo seu serviço de assistência ou por pessoal igualmente qualificado. Para as peças sobressalentes entre em contato com o serviço de assistência Lombardo S.r.l. Este produto contém uma fonte luminosa de classe de eficiência energética D.

Entre as várias soluções led, pode detectar uma mudança de temperatura cor, dependendo da tecnologia de construção do led. Entre diferentes lotes de fornecimento deve ser uma tolerância de 15% sobre a temperatura cor dos leds.

LOMBARDO S.r.l. não se responsabiliza por danos materiais e pessoas, devido a modificações, manipulação ou utilização não em conformidade com as especificações do produto.

Aparelho totalmente protegido contra o pó: IP 6X
Aparelho protegido contra os jatos de água: IP X5
Classe I. Led 5W. IP 65

Lombardo.

CLIC LED

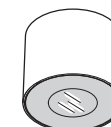

CLIC TOP



CLIC WALL

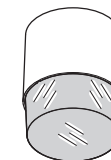

CLIC TOP UP

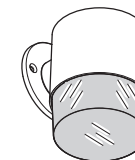

CLIC WALL UP

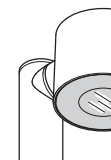

CLIC GARDEN

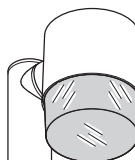

CLIC GARDEN UP



CLIC POST

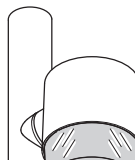

CLIC POST UP

LOMBARDO S.r.l.

Via Pizzigoni, 3 - 24060 VILLONGO (Bergamo) Italia
Tel. +39 035 939411 - Fax +39 035 939496
www.lombardo.it e-mail: info@lombardo.it

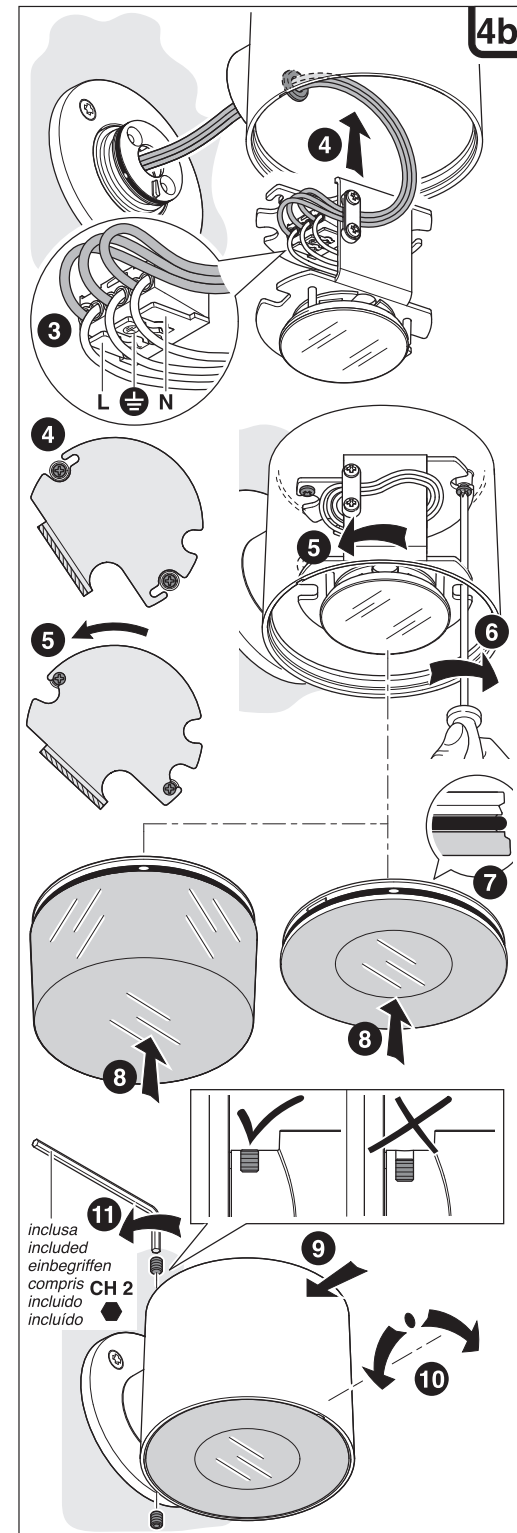
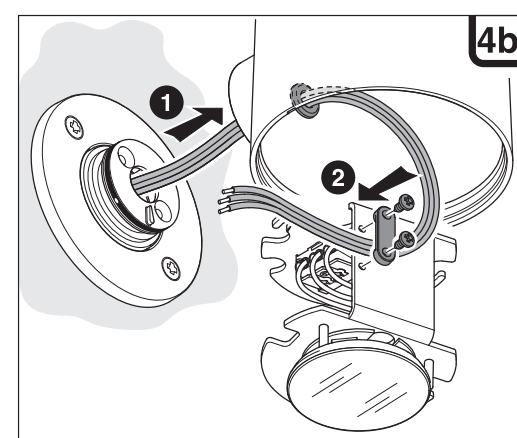
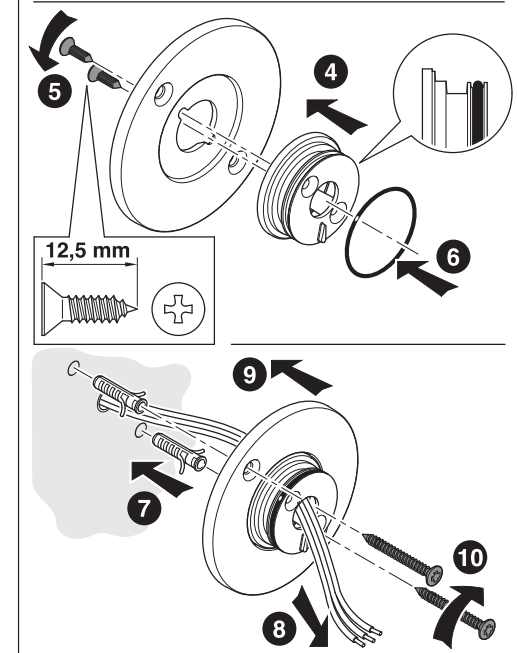
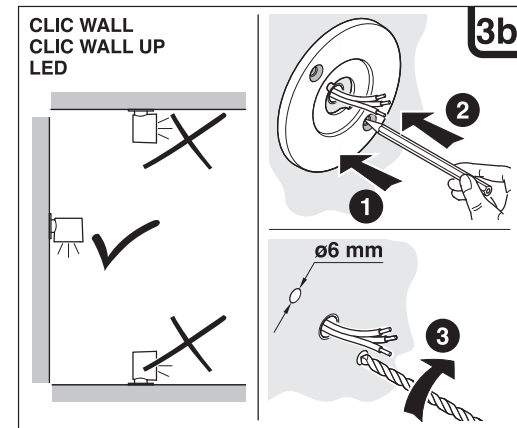
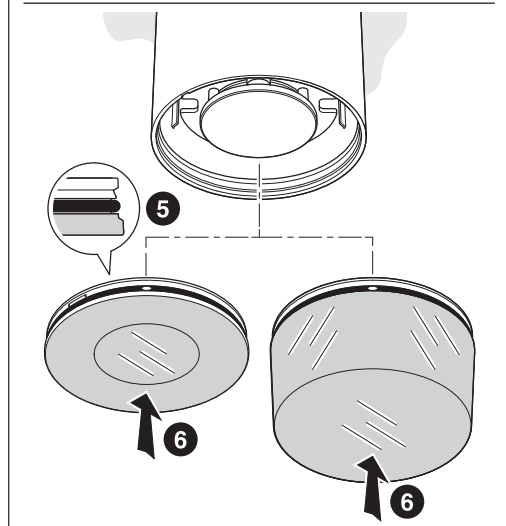
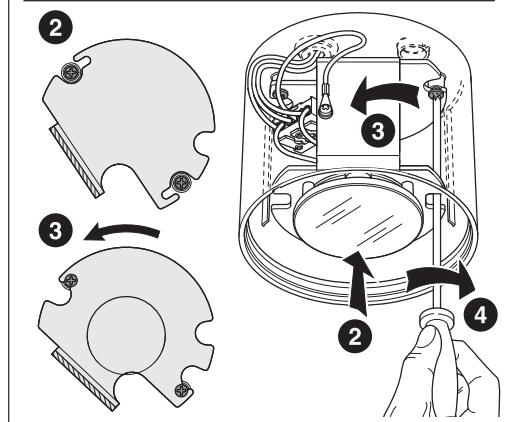
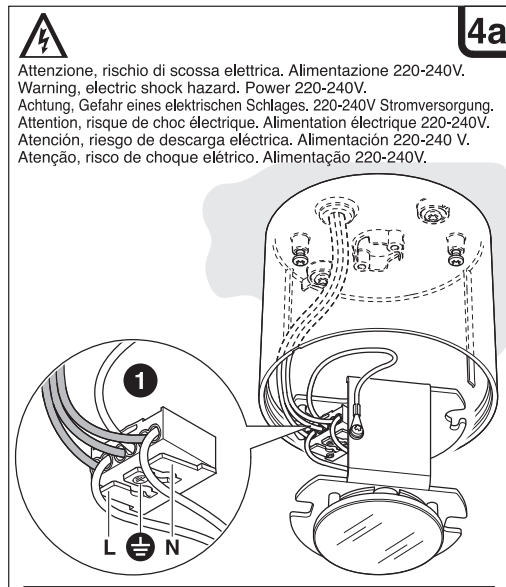
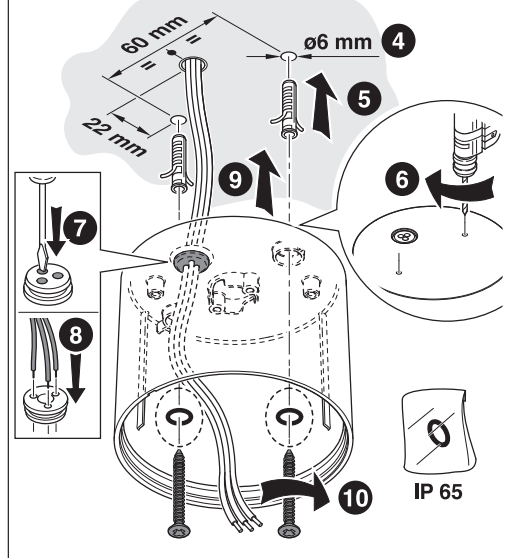
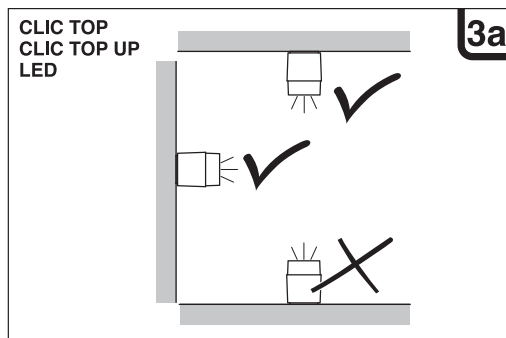
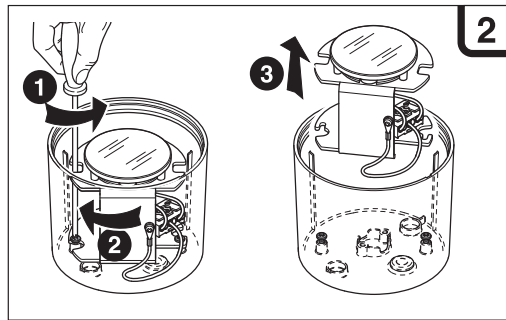
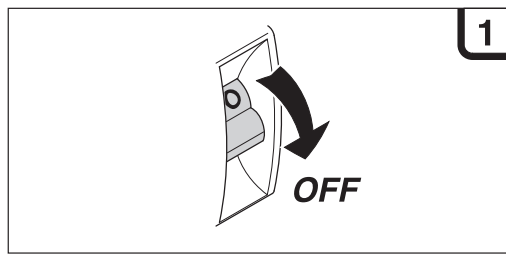

LOMBARDO



I Istruzioni per le operazioni di servizio per l'apparecchio di illuminazione

UK Instructions for service operations of the luminaire

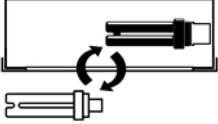
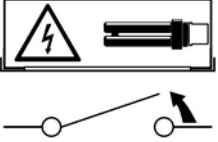
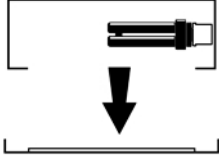
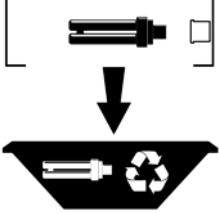
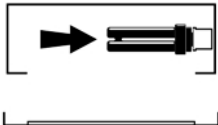
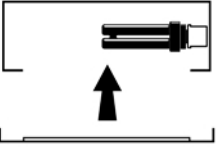
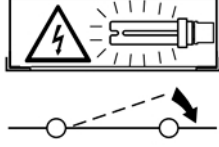
<p>Sostituire la lampada parzialmente esausta</p> <p><i>Replace the lamp partially exhausted</i></p> 	<p>Spegnimento Interrompere l'alimentazione all'apparecchio</p> <p><i>Switch off</i> <i>Cut the power supply to the luminaire</i></p> 	<p>Aprire l'apparecchio</p> <p><i>Open the luminaire</i></p> 	<p>Rimuovere la lampada esausta Portarla in un centro di riciclaggio</p> <p><i>Insert the new lamp</i> <i>Insert the new lamp into the socket</i></p> 
<p>Inserire nuova lampada Inserire la nuova lampada nel portalamпада</p> <p><i>Insert the new lamp</i> <i>Insert the new lamp into the socket</i></p> 	<p>Riposizionare ottica</p> <p><i>Place the diffuser/cover</i></p> 	<p>Effettuare prova di funzionamento</p> <p><i>Perform a functional test</i></p> 	

I Istruzioni per la pulizia dell'apparecchio di illuminazione

UK Instructions for cleaning of the luminaire

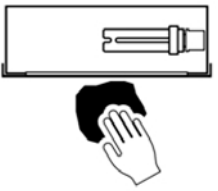
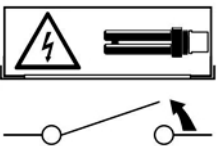
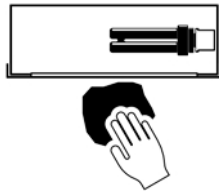
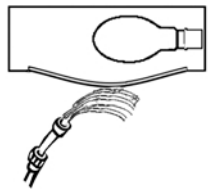
<p>Pulire l'apparecchio</p> <p><i>Clean the luminaire</i></p> 	<p>Spegnimento Interrompere l'alimentazione all'apparecchio</p> <p><i>Switch off</i> <i>Cut the power supply to the luminaire</i></p> 	<p>Spolverare l'ottica esterna</p> <p><i>Dust the diffuser/cover on the outside</i></p> 	<p>Lavare l'ottica esterna</p> <p><i>Wash the diffuser/cover on the outside</i></p> 
--	--	---	--

LOMBARDO

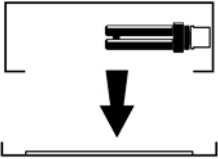
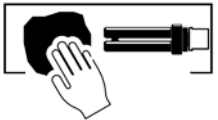
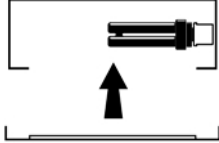
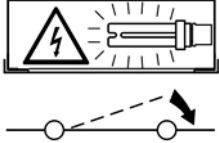

<p>Rimuovere l'ottica <i>Remove the diffuser/cover</i></p> 	<p>Pulire la parte interna dell'apparecchio di illuminazione <i>Clean the inside of the luminaire</i></p> 	<p>Riposizionare l'ottica <i>Place the diffuser/cover</i></p> 	<p>Effettuare la prova di funzionamento <i>Perform a functional test</i></p> 
---	--	---	---

I Istruzioni per il fine vita e lo smaltimento dei componenti

UK Instructions for end-life and disposal of components

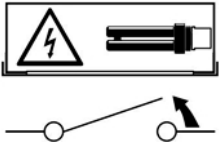
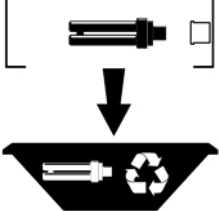
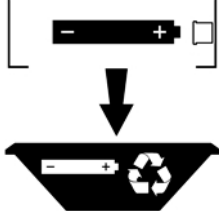
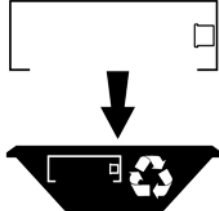
<p>Spegnimento Interrompere l'alimentazione all'apparecchio <i>Switch off</i> <i>Cut the power supply to the luminaire</i></p> 	<p>Rimuovere la/le lampada/e per la dismissione <i>Remove the lamp for disposal</i></p> 	<p>Rimuovere la batteria per la dismissione <i>Remove the battery for disposal</i></p> 	<p>Rimuovere l'apparecchio per la dismissione <i>Remove the luminaire for disposal</i></p> 
<p>Inviare i materiali ad un centro di raccolta RAEE <i>Send the materials to a WEEE collection center</i></p> 