



Catellani & Smith®



Par 18 Chandelier

with jack connection and metal base

chandelier

ISTRUZIONI DI MONTAGGIO / ASSEMBLY INSTRUCTIONS / INSTRUCTIONS DE MONTAGE / MONTAGEANLEITUNGEN / INSTRUCCIONES DE MONTAJE

I AVVERTENZE

- Si raccomanda che l'installazione venga eseguita da un elettricista abilitato.
- Togliere la tensione di alimentazione prima di effettuare l'installazione e per interventi di manutenzione o in caso di cattivo funzionamento.
- Si consiglia l'utilizzo dei guanti in dotazione. Per la pulizia della superficie utilizzare un piumino rimuovi-polvere.
- La lampada acquistata è garantita se installata e utilizzata nel rispetto delle specifiche del modello. Catellani & Smith declina ogni responsabilità per installazione non appropriata e/o uso diverso da quello indicato.
- La sorgente luminosa di questo apparecchio deve essere sostituita esclusivamente dal produttore, dal suo servizio di assistenza o da personale qualificato equivalente.

GB WARNINGS

- Only a qualified electrician should execute the installation.
- Switch off the power supply before installing, servicing or in case of malfunctioning.
- We suggest you to use the gloves provided. We recommend using a feather duster to clean the surfaces.
- The purchased lamp is guaranteed if installed and used in accordance with to the specifications of the model. Catellani & Smith is not responsible for inappropriate installation of the product and/or a different use than the one indicated.
- The lighting source of this appliance must be replaced by the manufacturer, by its technical service or by qualified electrician.

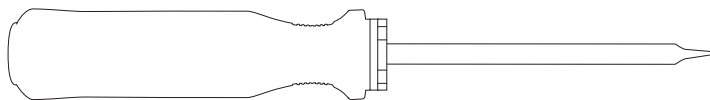

UTENSILI NECESSARI PER MONTAGGIO (NON INCLUSI) / TOOLS REQUIRED FOR MOUNTING (NOT SUPPLIED)



■ Per l'installazione munirsi di cacciavite piatto – punta standard

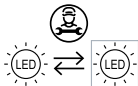

In order to execute the installation, use a flat-head screwdriver – standard

tensione di rete / voltage	<input type="checkbox"/> 220-240V	<input type="checkbox"/> 110V	<input type="checkbox"/> 110-240V
LED	<input type="checkbox"/> x 1,7W 24Vdc		
alimentatore / driver	24Vdc constant voltage driver		
dimmerazione / dimming	<input type="checkbox"/> IGBT/Triac	<input type="checkbox"/> 1...10V	<input type="checkbox"/> PUSH <input type="checkbox"/> DALI
layout n.	<input type="text"/>	quality check n.	<input type="text"/>
I classe class	IP20 classe di protezione protection class	 persone suggerite per il montaggio people required for mounting	   MADE IN ITALY

BASE IN METALLO / METAL BASE



quadrata / square

30x30 cm

60x60 cm



rotonda / round

Ø 40 cm

Ø 78 cm



rettangolare / rectangular

90x30 cm

150x30 cm

150x60 cm

custom / custom

cm

ATTENZIONE:

i componenti indicati nei disegni possono variare
per quantità e forma a seconda del modello

WARNING:

the components mentioned in the drawing may vary in quantity
and shape according to the model.

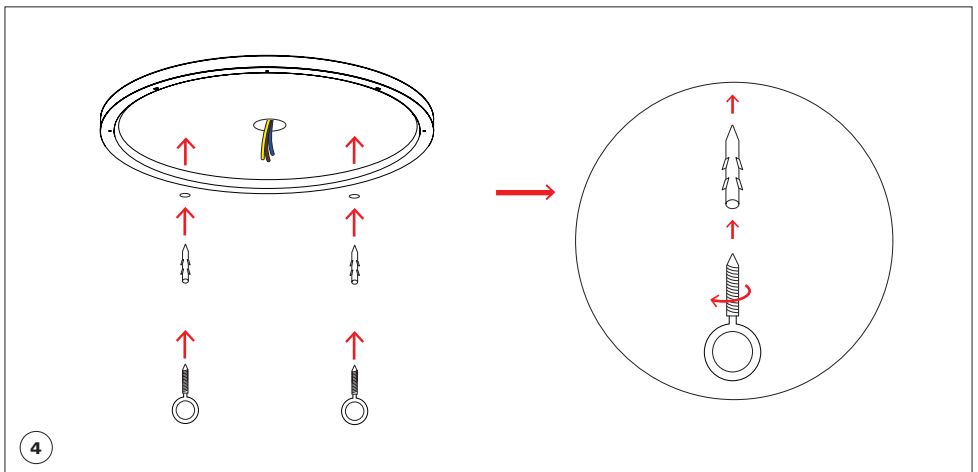
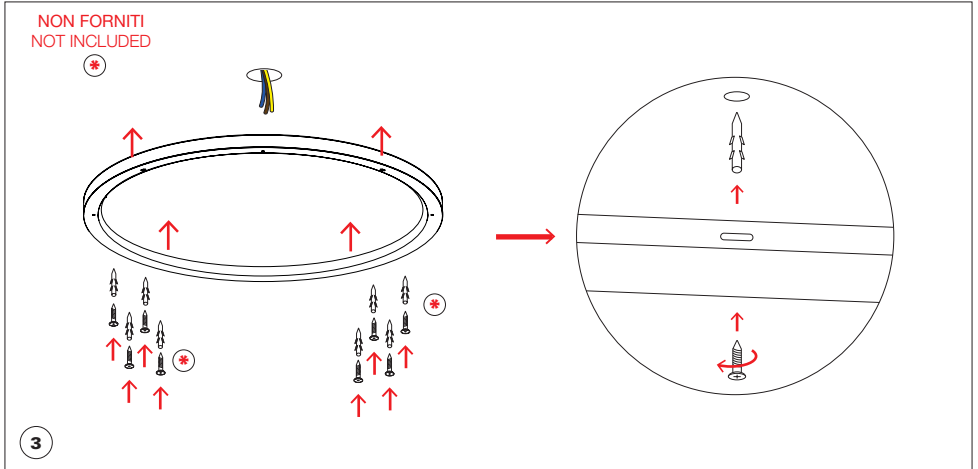
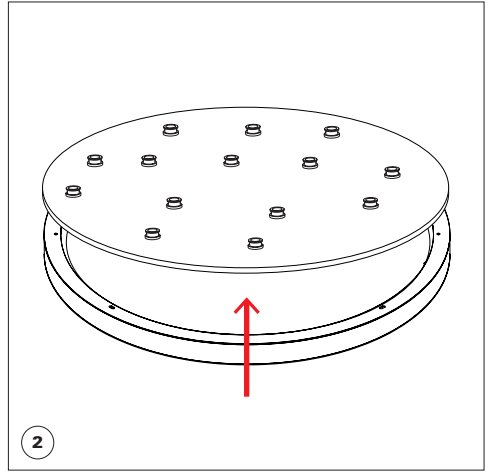
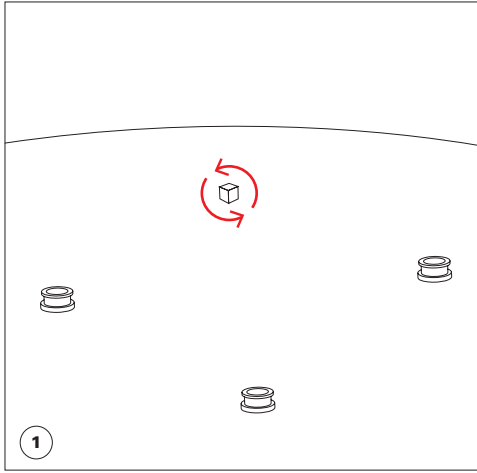

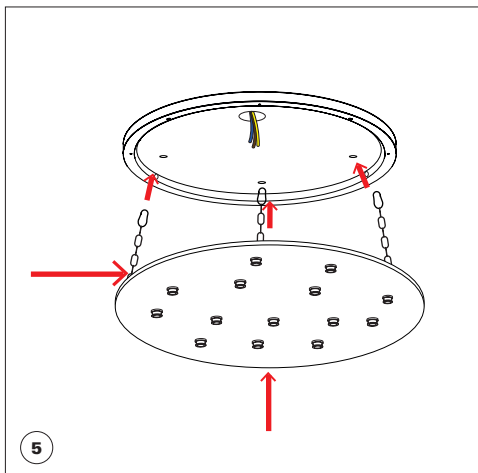
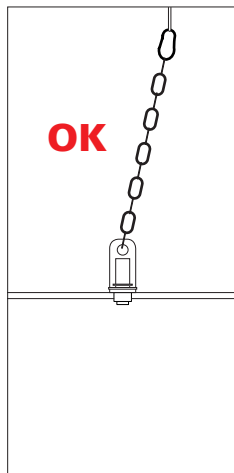
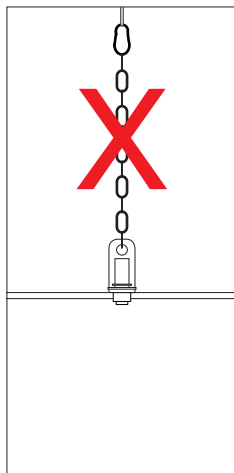

5

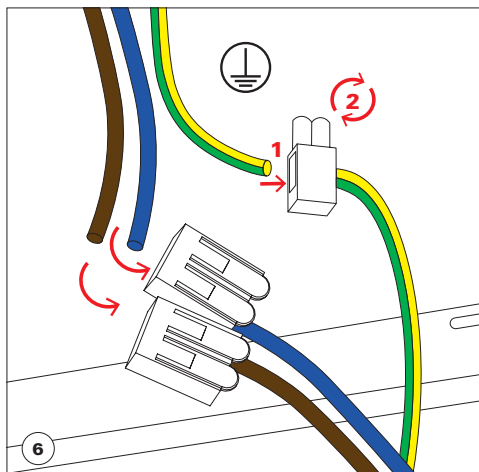

6

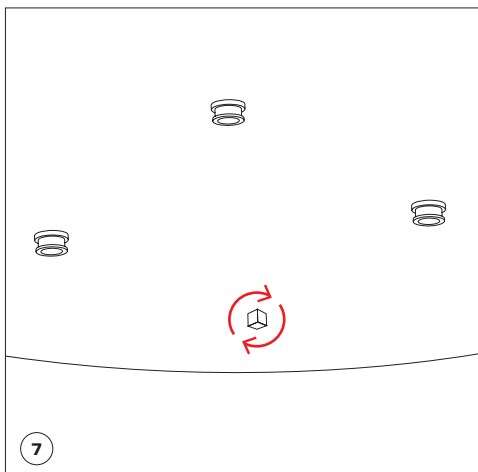

7

ATTENZIONE: suggeriamo di connettere la tensione di alimentazione 24V prima di posizionare i pendenti, così da verificarne immediatamente il funzionamento.

WARNING: it is suggested to switch on the 24V low voltage power supply before installing each single pendant, in order to check their functioning immediately.

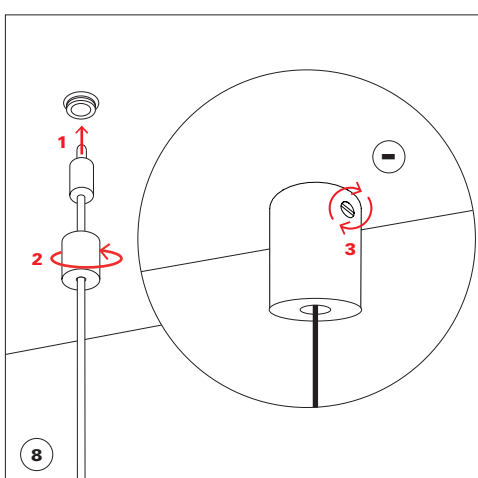

8

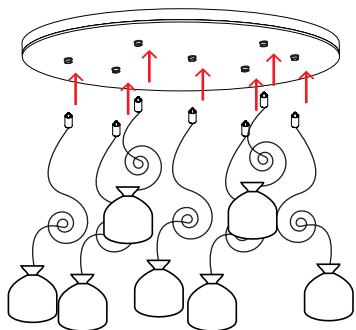

montare pendenti insacchettati
keep the pendants packed during installation

10

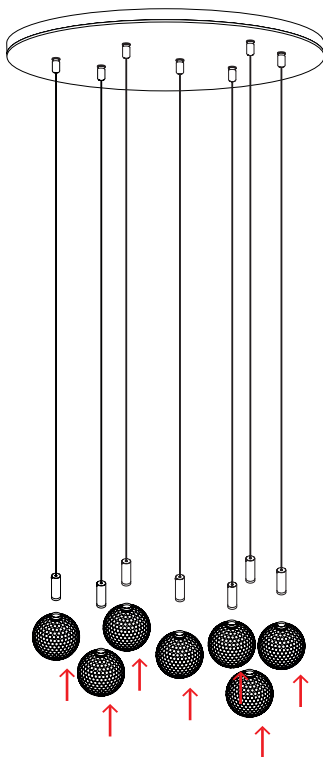

11

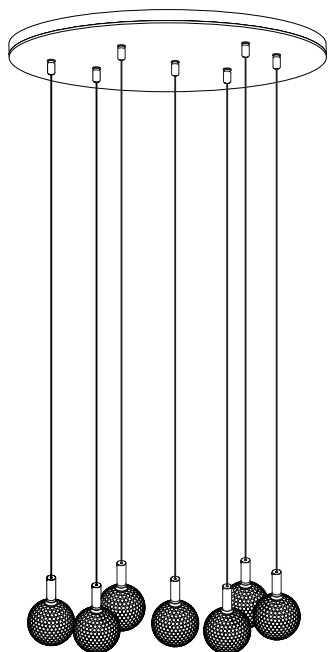

12

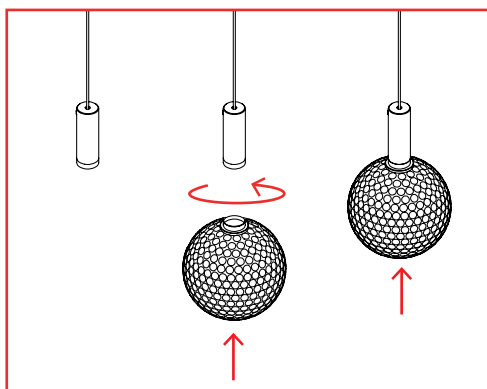

ATTENZIONE

Montare lo schermo in vetro dopo aver connesso il jack.

WARNING

We suggest to mount the glass sphere after connecting the jack.

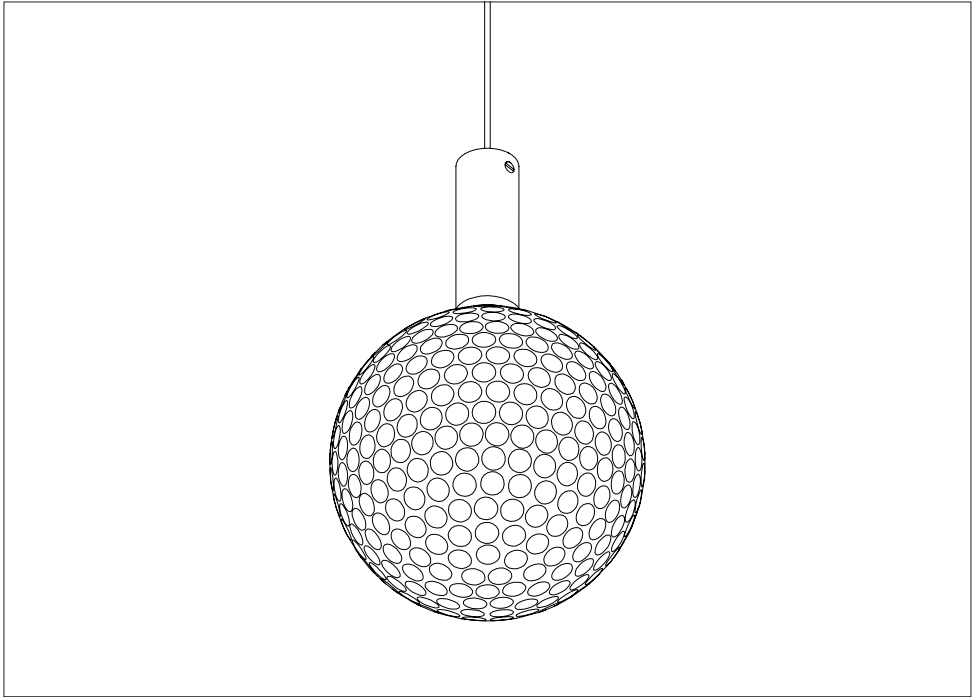

Sostituzione LED
LED replacement

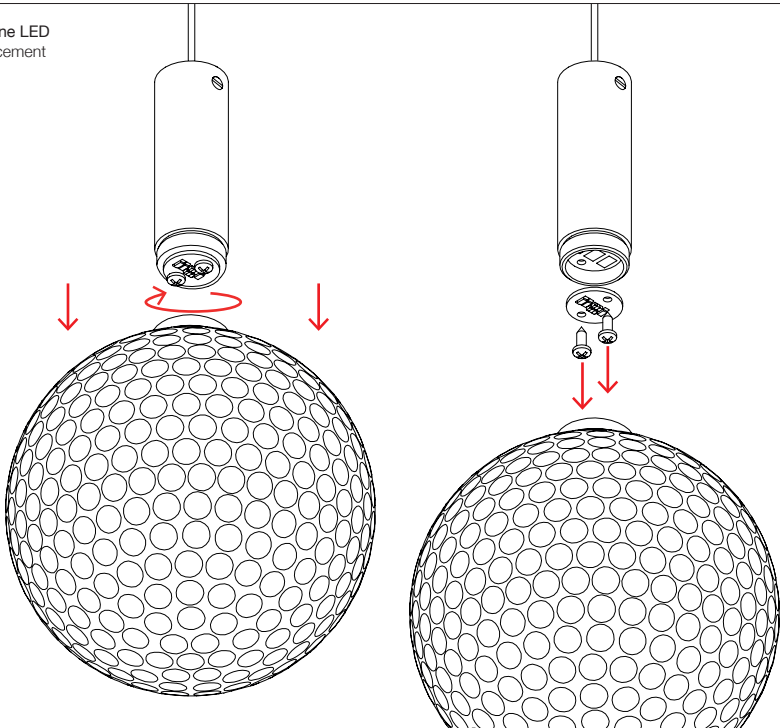



updated 04/2024

Questa apparecchiatura non deve essere smaltita come un normale rifiuto urbano, ma deve essere portata nel punto di raccolta appropriato per il riciclaggio di apparecchiature elettriche ed elettroniche. Provvedendo a smaltire questo prodotto in modo appropriato, si contribuisce ad evitare potenziali conseguenze negative per l'ambiente e per la salute umana, che potrebbero derivare da uno smaltimento inadeguato del prodotto. Per informazioni più dettagliate sul riciclaggio di questo prodotto, contattare l'ufficio comunale, il servizio locale di smaltimento rifiuti o il rivenditore presso il quale è stato acquistato il prodotto.

This equipment may not be treated as household waste. Instead it shall be handed over to the applicable collection point for the recycling of electrical and electronic equipment. By ensuring this product is disposed of correctly, you will help prevent potential negative consequences for the environment and human health, which could otherwise be caused by inappropriate waste handling of this product. For more detailed information about the recycling of this product, please contact your local city office, your household waste disposal or the dealer where you purchased this product.

