

Mounting Instruction

Seppe Van Heusden - Seam

Floor Lamp

B7221604

Luminary specs

TYPE Floor Lamp

MATERIAL Steel - Porcelain

COLOUR White

DIMENSIONS

L20 x W71 H196 cm

L7 7/8 x W28 H77 1/8 inch

DIMMING FUNCTION Yes

CABLE LENGTH 5 m

Bulb type

E27

Bulb included

Max. 5W

Max. 240V

Class II

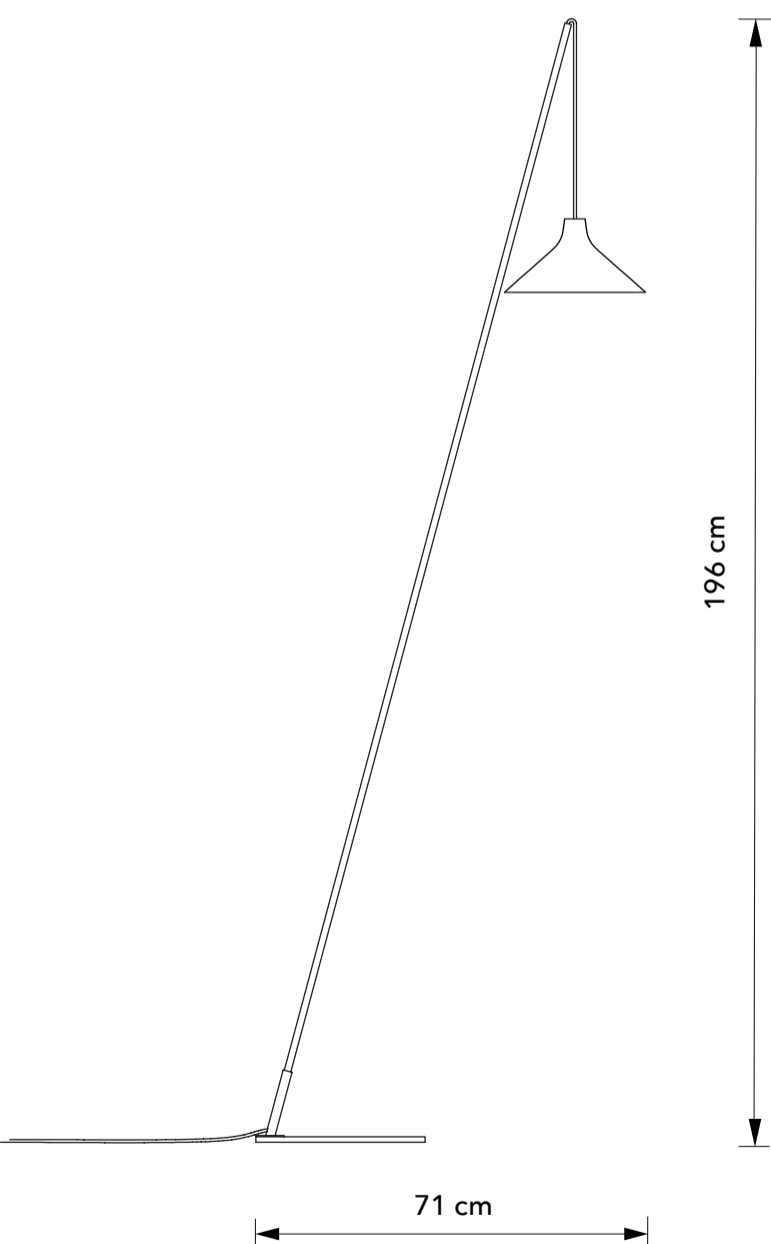
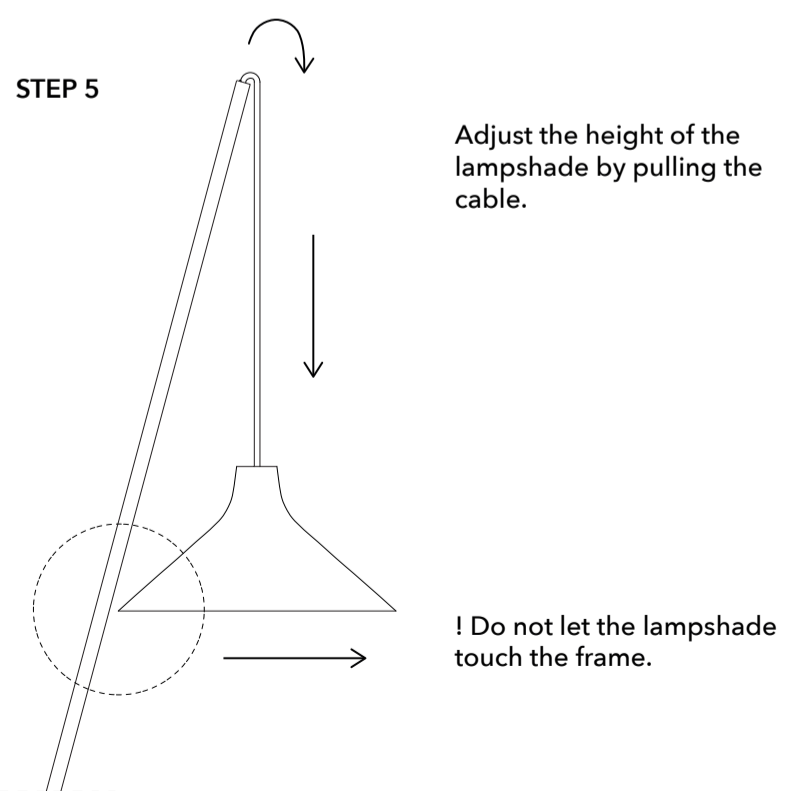
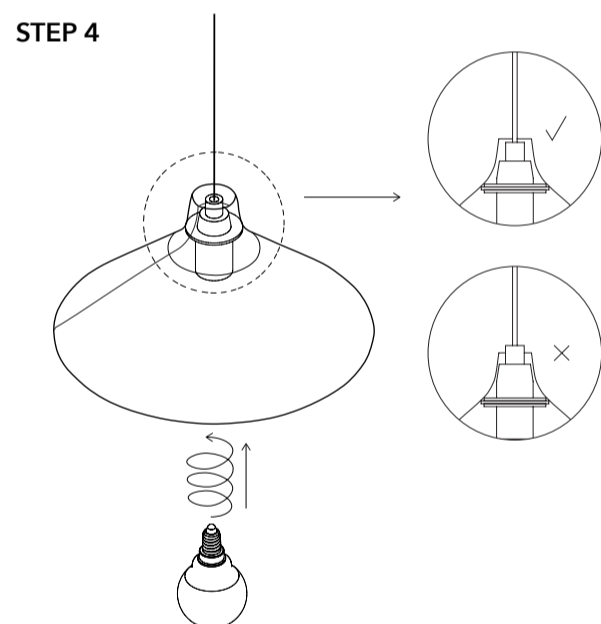
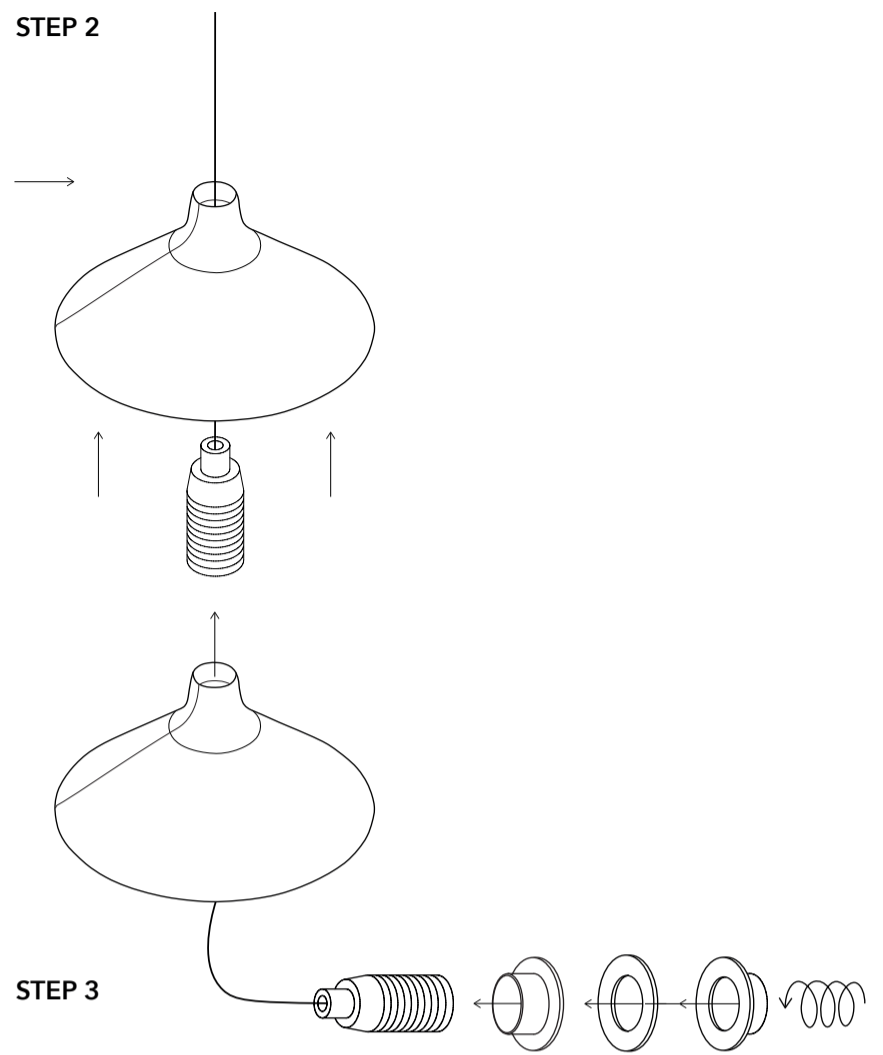
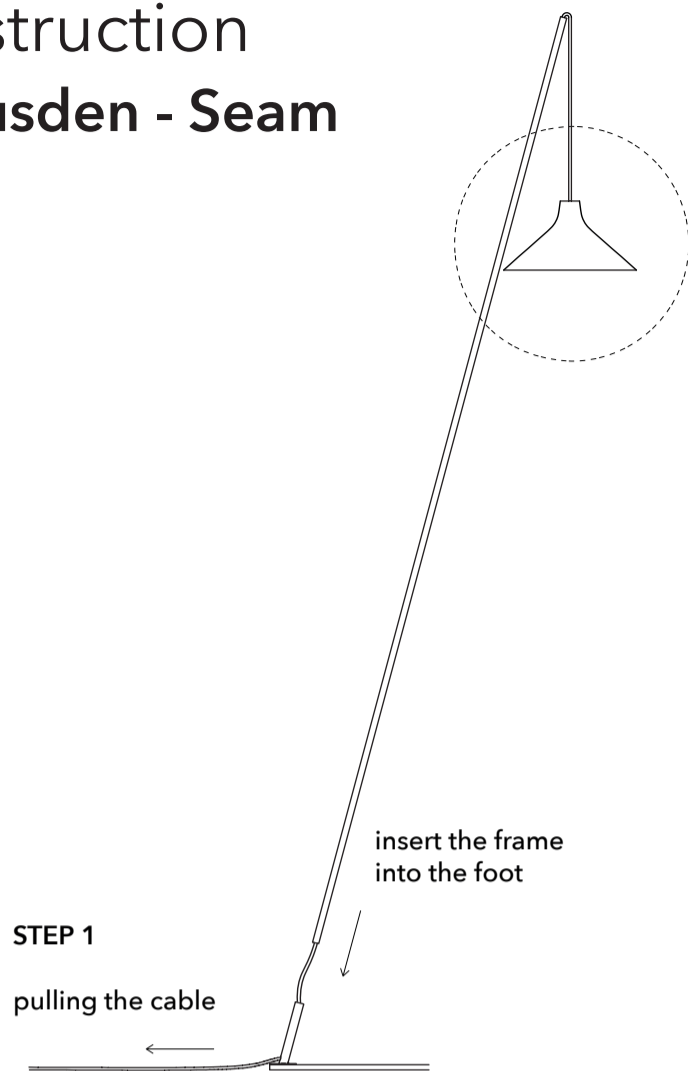

WWW.SERAX.COM













Veldkant 21, 2550 Kontich, Belgium - Tel. +32 3 458 05 82

SERAX

Safety Precautions

Please study the instruction manual and below information carefully before installing or using this product.
Please keep this user manual for further reference.

1. The luminaires may only be installed by authorized and qualified technicians according the valid regulations for electrical installation.
2. Maintenance of the luminaires is limited to their surfaces. During maintenance no moisture can come into contact with any areas of the terminal connections or volta control parts.
3. The electrical supply must be switched off at the outset, preferably by means of a switch in the distribution box, before any installation, maintenance or repair work is undertaken.
4. Exterior light must not be installed during rain.
5. Take account of the minimal separation distance from other objects and the room required around the fitting.
6. If in any doubt, consult a professional, taking local installation requirements into account. Some countries stipulate that lighting may be installed only by registered installers.
7. Clamping screws in electrical connections must be adequately tightened. This is particularly the case with 12V low voltage conductors.
8. When replacing a halogen lamp, wait for it to cool, for a minimum of 5 minutes.
9. Clean with a clean, dry cloth or brush, use no solvents or abrasives. Avoid dampness on all electrical components.
10. Take account of all available technical information.
11. Take note of the symbols when connecting wires:
 - N = Neutral
 - L = Live
 -  = Earth
12. If the external flexible cable or cord of this luminaire is damaged, it shall be exclusively replaced by the manufacturer or his service agent or a similar qualified person in order to avoid a hazard.
13. Meaning of symbols:

	For indoor use only, where direct contact with water is impossible
	Protection class 1: the fitting must be earthed
	Protection class 2: the fitting is double insulated and does not require earthing
	Protection class 3: the fitting is low voltage
	Observe the indicated minimum distance between the lamp and the illuminated materials/objects
	Only the self-screening halogen illuminants should be used with the luminaire
	Strip the wire to the indicated length
	Connect using the specified cable
	The fixture can be used in combination with a dimmer. Consult the sales outlet for the correct type of dimmer (important in the case of 12V fittings)
	The maximum wattage indicated in each lighting unit, for example, must not be exceeded
	This luminaire cannot be disposed together with normal domestic waste in standard rubbish bin, but you have to bring it to a staging area for electrical waste
	This luminaire was designed to work only with the indicated voltage
