

NJP WALL LAMP

NJP Wall Lamp - 5743147461

The fixture provides direct glare-free horizontal light while reflecting some of the light through the rear of the head, illuminating the top of the arm. The ergonomic design of the fixture head shapes the light and gives optimal light direction. A simple mechanical system provides great freedom of movement, so the light can always be set in the ideal position in the workspace. The shade is painted white on the inside, reflecting comfortable diffused light.



nendo

In 2002 Oki Sato founded nendo design studio. nendo means 'clay' in Japanese – or more specifically, modelling clay such as plasticine. A unique material that makes it easy to do creative modelling.



Set location -
The Qvest



Wohnidee suits in Radisson Blu Hotel

Product info

Environmental Product Specification

This product is compliant with the requirements contained in the European Directives, RoHS Directive 2011/65 and 2015/863. This product is designed so that 100% of the product can be disassembled and reused.

Information

Driver fitted externally on cord. The light has two built-in intensities. The weight includes the wall bracket. Wall mounting depends on selected arm length. This product is fitted with an integrated energy-saving LED light source. Should you wish to replace it, please contact Louis Poulsen so we can help you purchase the correct LED Replacement Kit. Please note that LED-replacement should always be carried out by an authorised electrician.

Mounting

Cord type: Black or white. Cord length: 3,3m (short arm), 2,3m (Long arm). Switch: On the fixture head. Timer function: 4 hours or 8 hours. LED driver: separate, plugs into power outlet. The light has two built-in intensities.

Finish

White, Black or Light Aluminium Grey, powder coated.

Materials

Arms and lamp head: Aluminium. Joints: Anodised Aluminium. Wall bracket: Aluminium.

Sizes and weights

width x Height x Length (mm) | 150 x 600 x 600 Max 1.0 kg | 150 x 200 x 300 Max 0.7 kg | 149 x 814 x 509 Max 1.7 kg | 149 x 219 x 296 Max 1.0 kg

Class

Ingress protection IP20. Electric shock protection II w/o ground.

Light source

LED 3000K 10W
Lumen: 550

Information

Driver fitted externally on cord. The light has two built-in intensities. The weight includes the wall bracket. Wall mounting depends on selected arm length. This product is fitted with an integrated energy-saving LED light source. Should you wish to replace it, please contact Louis Poulsen so we can help you purchase the correct LED Replacement Kit. Please note that LED-replacement should always be carried out by an authorised electrician.

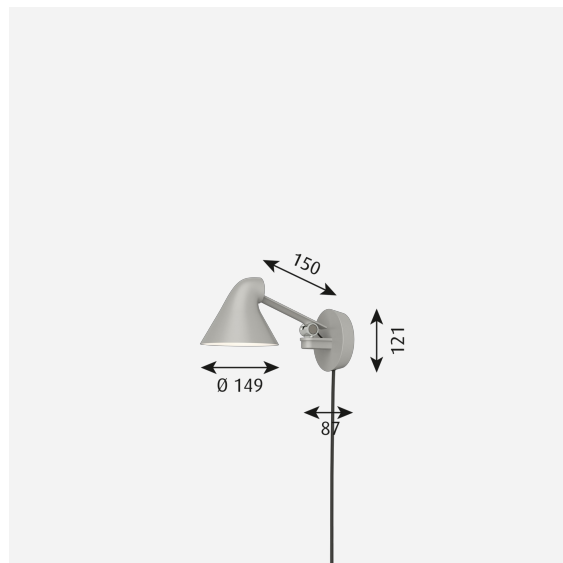

Related products



NJP Table Lamp



NJP Floor Lamp



NJP Mini Table Lamp

Light distribution diagrams

Cartesian

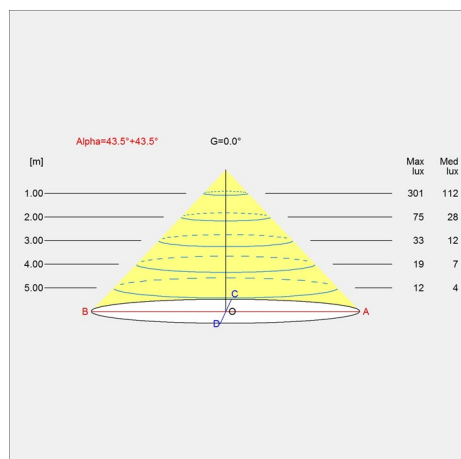

Isolux

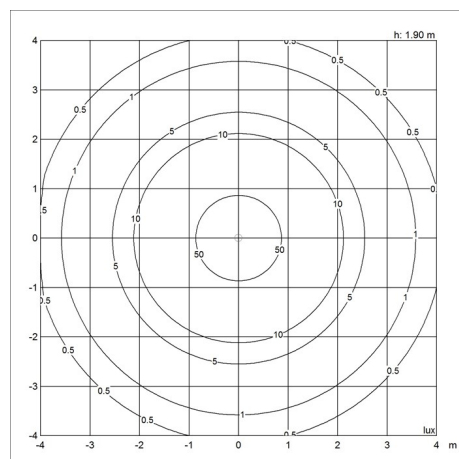

Polar

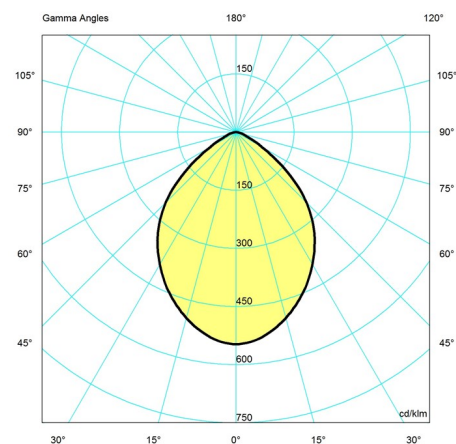

Spare parts & accessories

Product	Variant number
Adaptor 12V black	5744164867
Adaptor 12V white	5744164870
NJP bushing plast	5744165183
NJP replacement kit LED w/wire 27K	5744165947
NJP replacement kit LED w/wire 3K	5744165976
NJP Wall, Black bracket	5743163160
NJP Wall, White bracket	5743163173
NJP Wall, Light Grey bracket	5743163364

Data specifications

Colour	Light aluminium grey (RAL 9006 G: 60)	Length	296
Width	149	Height	219
Built-in Height	-	IP class	-
Class	II	Net Weight	1.0
Standby (W)	-	Power Factor (P = 100 % / P = 50 %)	-

NJP Wall Lamp

Inrush Current	-
Kelvin	3000
SDCM	3
Watt	10
Light control	-
UGR Transversal / Axial	19.4/19.4
Driver life	>50.000

Light source	LED 3000K 10W
CRI	97
Lumen	550
Efficacy	55
Min. Dim Level (%)	-
L80B50 (hours)	>100.000