

Assembly & Care Guide

Tense Multi Canopy for 5 pcs.

Panter & Tourron

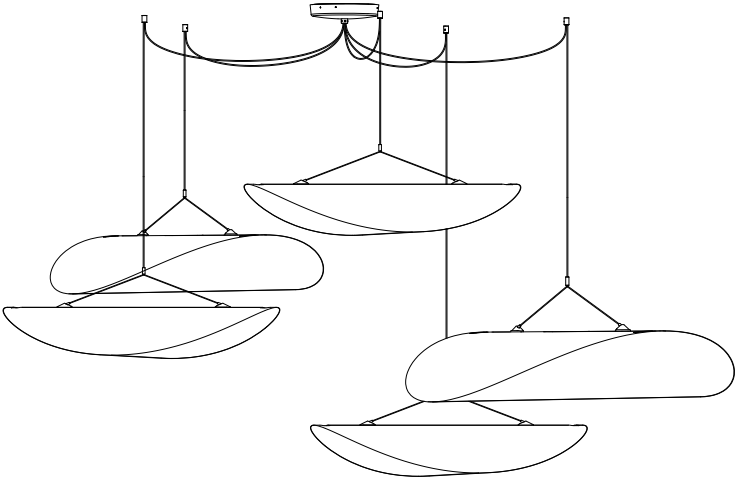

Thank you for choosing the Tense Multi Canopy for 5 pcs. designed by Panter & Tourron. We hope you will enjoy it as much as we enjoyed making it. Please follow this guide to ensure correct assembly, installation and care of your New Works product.

Content

Installation of Canopy

Guide for the installation of Tense Multi Canopy for 5 pcs.	5
1. Placement and mounting	5
2. Insert cables into ceiling mount	6
3. Mount canopy cover	7
4. Insert cables into canopy cover	8
5. Connect cable in driver	8
6. Connect driver with connector box	9
7. Connect and fit everything inside the canopy	10
8. Mount canopy cover	10

Shade Assembly

Guide for the assembly of Tense Shade	12
1. Unfold the shade on a flat surface	12
2. Press and click	13
3. Center the joint	13
4. Fold the patch	13
5. Repeat previous steps	14
6. End of shade assembly	14

Pendant Assembly

Guide for assembly of Tense Pendant	16
1. Insert light source	17
2. Click on magnets	17
3. Turn on the light	18

Attention

Please read these instructions carefully and retain them for future reference to ensure that the product is used correctly. For your safety, please study each step of this guide first.

New Works will not take any responsibility for accidents or injuries that occurs due to misuse or unintended use of the product. This includes use of the product in unintended environments, use of non-compatible light sources, adapters, other electrical peripherals or any attempts to alter the product.

If you have any questions, please do not hesitate to contact us via email: info@newworks.dk

Safety Precautions

The lamp is only intended for indoor use, consult a professionally qualified electrician if any doubt. Follow the guidance:

The Multi Canopy can fit 5 pcs. of Tense Pendants regardless of the diameter of the pendants.

The light bulb and lamp exterior may get hot after prolonged use. Do not try and open the product, any attempt to open the product can result in product failure, of which New Works ApS will not take responsibility.

Keep the product out of children's reach. Dispose of the packaging and do not allow children to play with it. Do not modify the product in any way.

Cleaning Instructions

Wipe the product with a soft dry or moist cloth. Do not use any abrasive cleaning tools, and never use strong cleaning agents such as household glass cleaner, white spirit, or turpentine.

Required Tools

- Power drill
- Drill bit
- Bits, pozidrive or philips
- Unbrako wrench, size 2 and 3
- Marker
- Screws
- Wall plugs



Installation of Canopy

Guide for the installation of Tense Multi Canopy for 5 pcs.

A

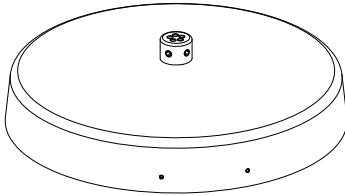

Product assembly

Guide for the installation of Tense Multi Canopy for 5 pcs.

A - Canopy

B - 5 pcs. Ceiling Mounts

Attention: Make sure to use correct screws.

New Works does not take responsibility for unsafe assembly.

B

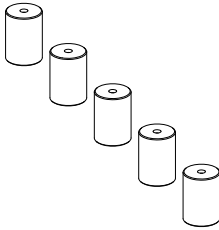

III. 1

1. Placement and mounting

Decide where the canopy and five ceiling mounts is to be hung.

Dismount the canopy cover.

Place the canopy bracket on the ceiling.

Make marks through the bracket.

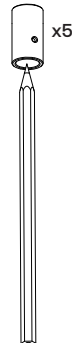
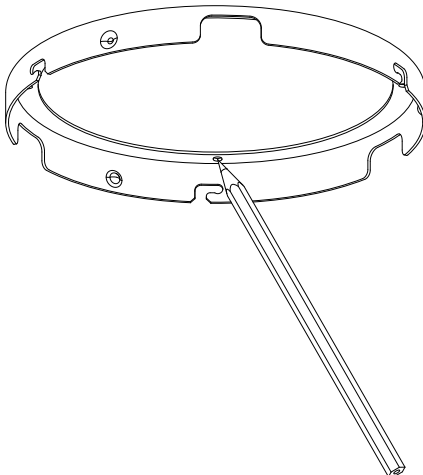

III. 2

Drill four holes for the canopy bracket and one hole for each of the ceiling mounts.

Put in plugs and mount canopy bracket and ceiling mounts.

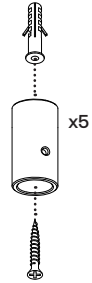
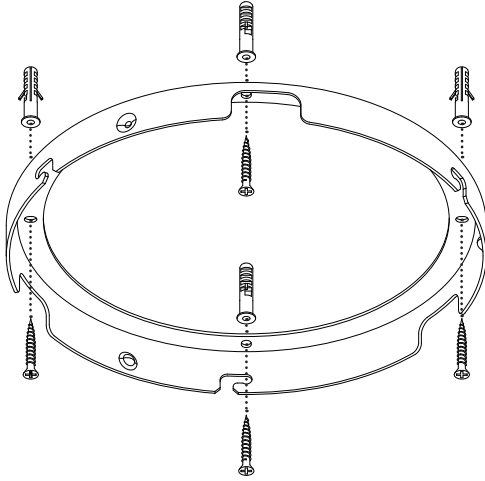

III. 3

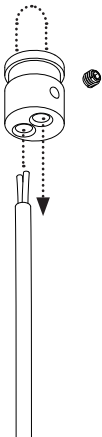
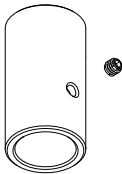

III. 4

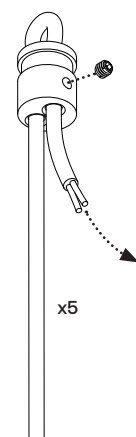
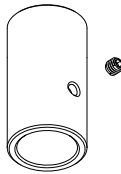

2. Insert cables into ceiling mount

Insert the Tense Pendant cable in the ceiling mount insert and pull it through the first hole and put it down the second one. Pull it in the wished length and insert the pinion screw.

Repeat this step five times.

Attention: Don't apply too much force when pulling the cable and ensure that the cable is not damaged.

Don't over tighten the pinion screw.

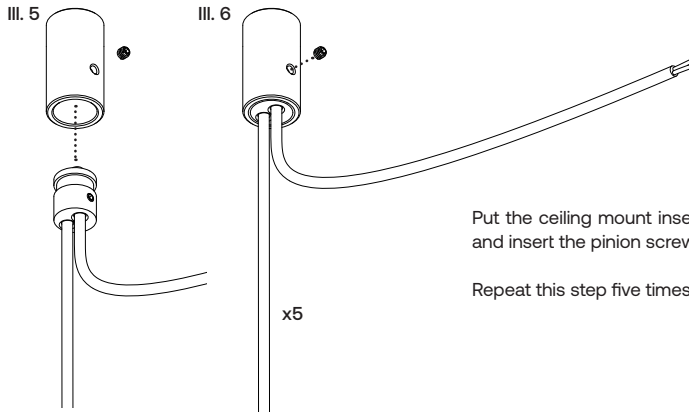

Put the ceiling mount insert into the ceiling mount and insert the pinion screw.

Repeat this step five times.

III. 7

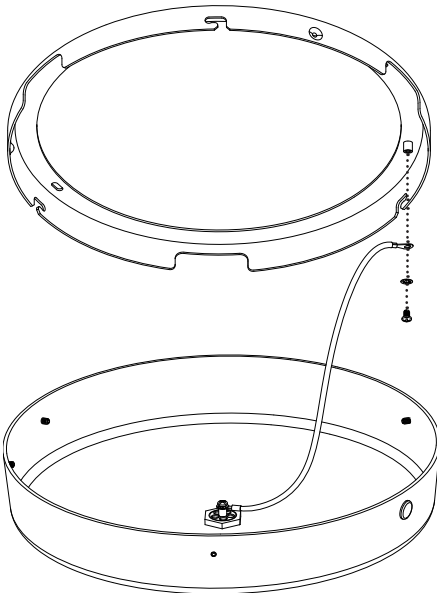

3. Mount canopy cover

Mount the canopy cover on the canopy bracket with the earth wire.

Insert the screw through the washer and earth wire ring and into the thread in the bracket.

III. 8

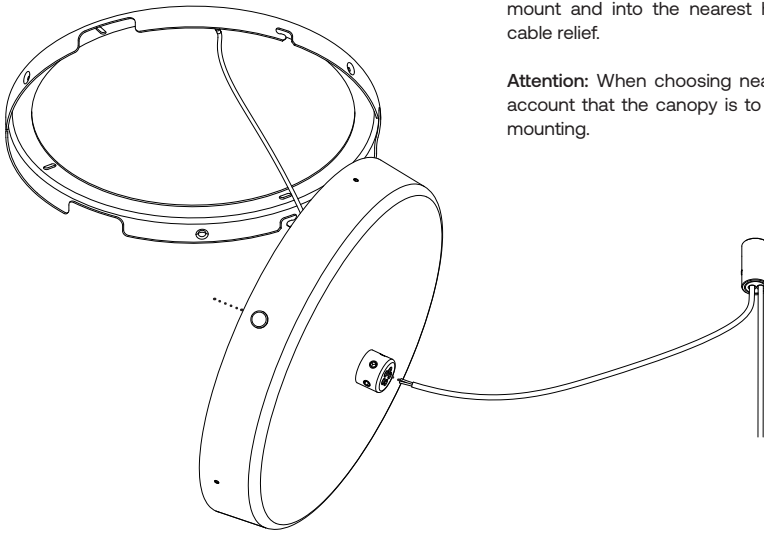

4. Insert cables into canopy cover

Insert the Tense Pendant cable from a ceiling mount and into the nearest hole in the divided cable relief.

Attention: When choosing nearest hole take into account that the canopy is to be rotated for final mounting.

III. 9

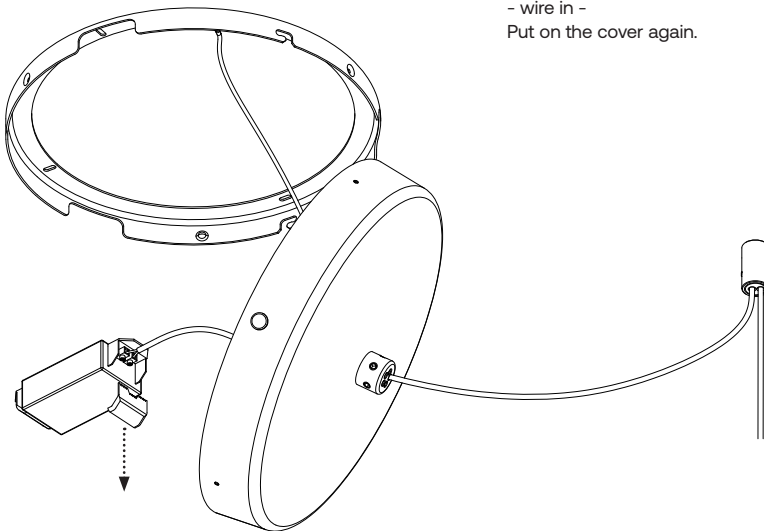

5. Connect cable in driver

Remove the cover. Connect the cable in the driver:

+ wire in +

- wire in -

Put on the cover again.

III. 10

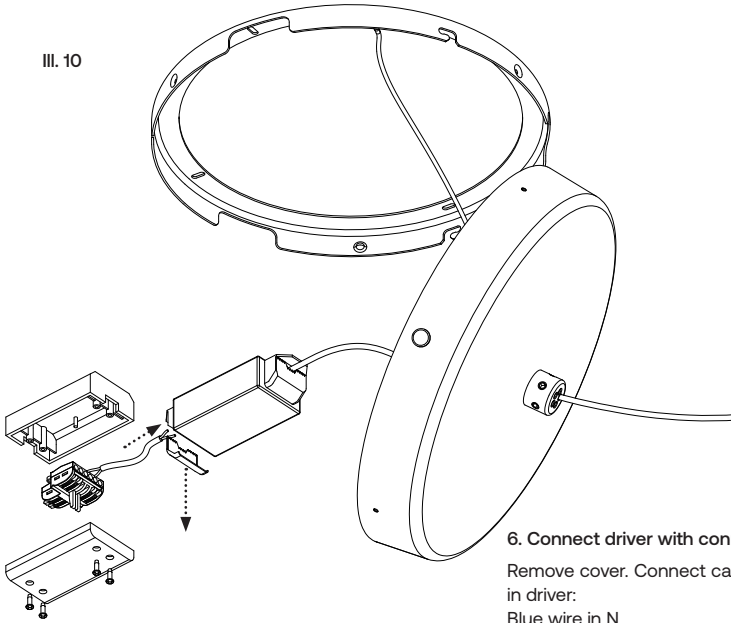

6. Connect driver with connector box

Remove cover. Connect cable from connector box in driver:

Blue wire in N

Brown wire in L

Put on the cover again.

III. 11

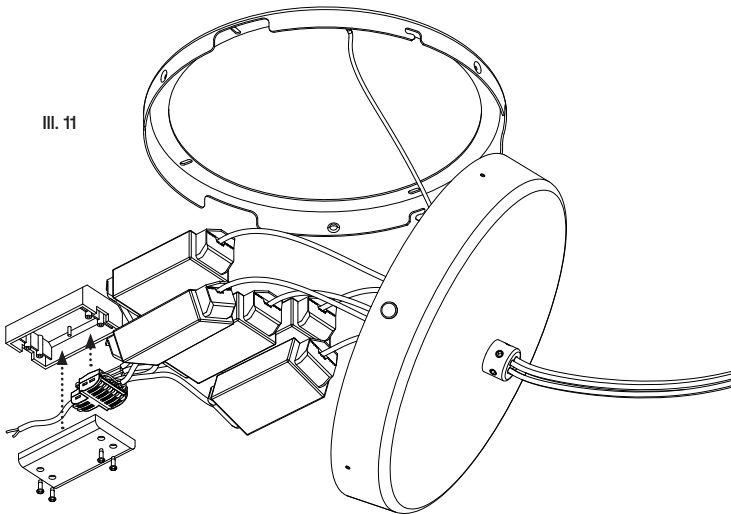

Repeat steps with all cables and drivers.
Close the connector box.

III. 12

7. Connect and fit everything inside the canopy

Connect cable from connector box to the outlet.
Spread out the drivers and connector box inside the canopy cover.

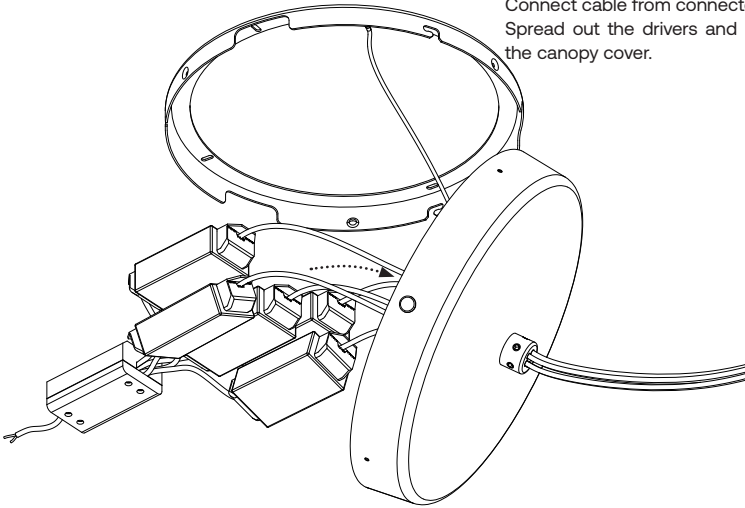

III. 13

8. Mount canopy cover

Bring the canopy to the bracket and rotate it until the pins are in place.
Find the pinion screw and tighten it so the canopy cover can not rotate.

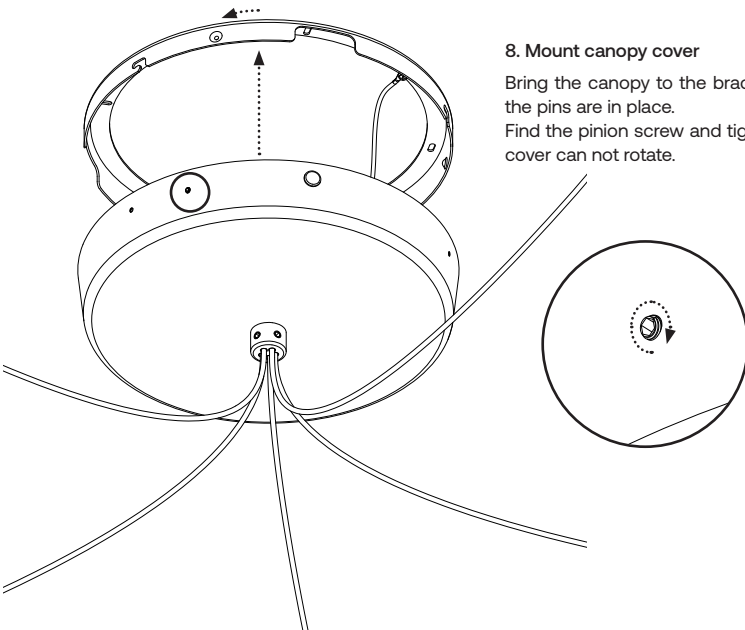

Shade Assembly

Guide for the assembly of Tense Shade

A

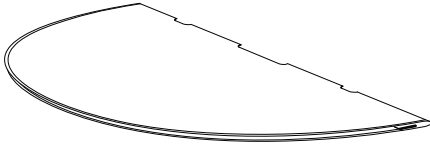

Diffuser Assembly

Guide for assembly of Tense shade.

A - 5 pcs. Tense shade

Attention: New Works does not take responsibility for unsafe assembly.

Attention: The shade material Tyvek is strong but be careful when assembling as it can be ripped apart at edges or sharp corners.

III. 14

1. Unfold the shade on a flat surface.

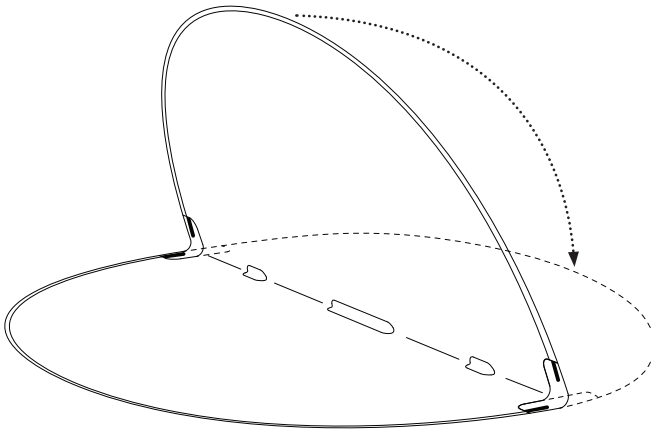

III. 15

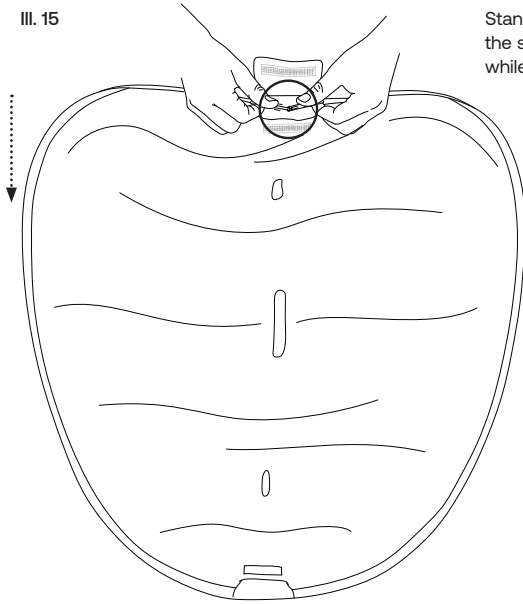

2. Press and click

Stand up while holding the shade. Gently press the shade towards the floor to loosen the tensions while clicking the to ends together.

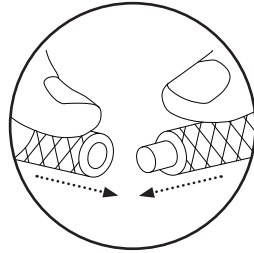

III. 16

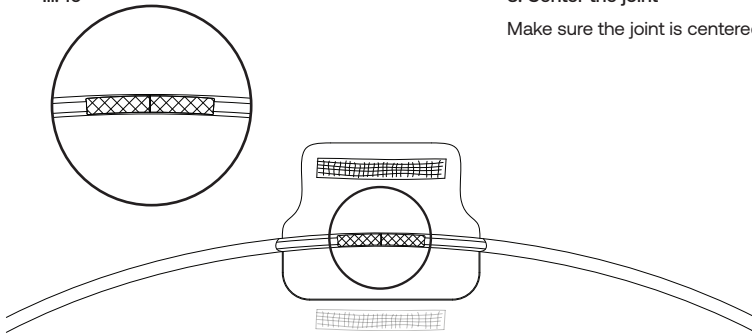

3. Center the joint

Make sure the joint is centered in the opening.

III. 17

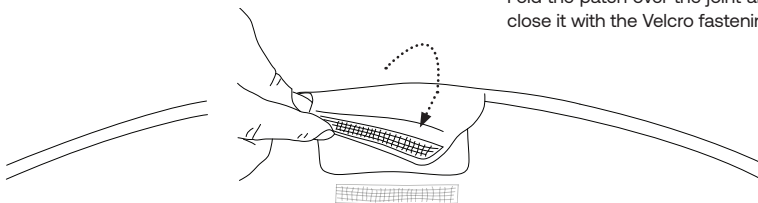

4. Fold the patch

Fold the patch over the joint and inside the hole to close it with the Velcro fastening.

III. 18

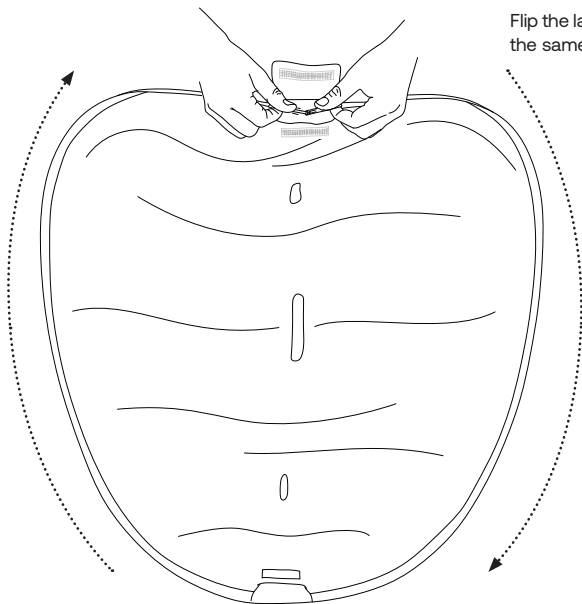

5. Repeat previous steps

Flip the lamp shade 180 degrees around and repeat the same steps on this side of the shade.

III. 19

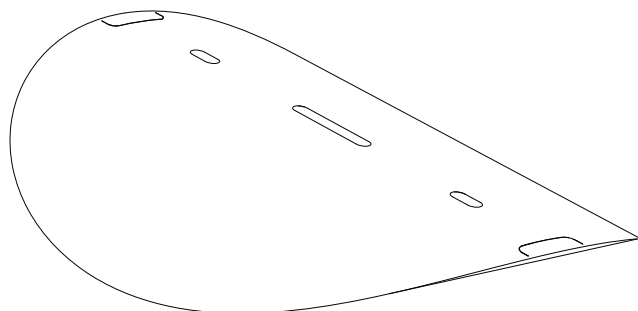

6. End of shade assembly

The Tense shade is now assembled correctly.

Pendant Assembly

Guide for the assembly of Tense Pendant

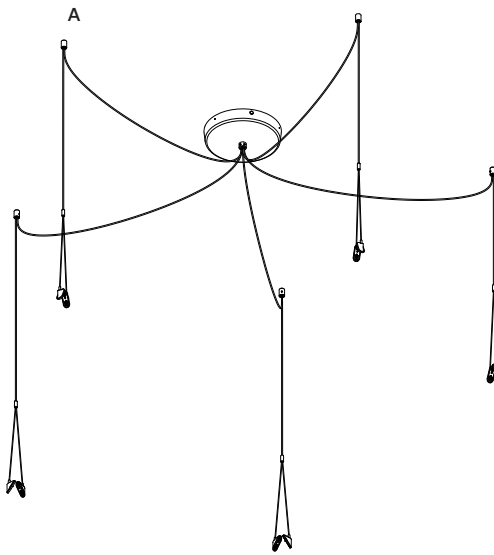

Pendant assembly

Guide for assembly of Tense Pendant

A - Tense Multi Canopy for 5 pcs.

B - 5 pcs. Tense shade

C - 5 pcs. Tense light source

Attention: New Works does not take responsibility for unsafe assembly.

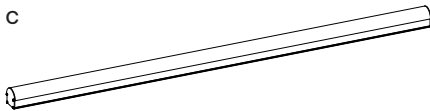
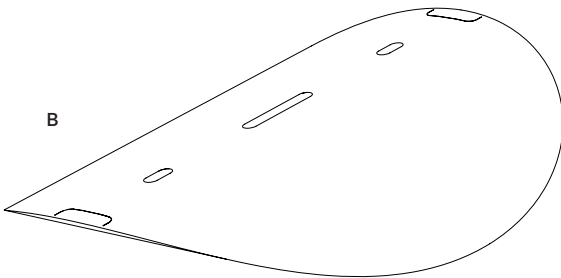

III. 20

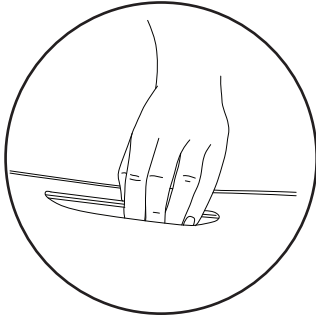

1. Insert light source

Slide the light source into the diffuser and grab it through the hole in middle. Make sure it is centered inside the shade.

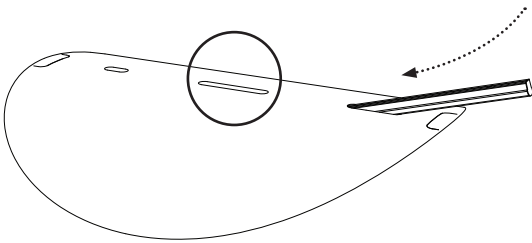

III. 21

2. Click on magnets

Continue to hold the shade by the light source while clicking the two cables to the light source. Please note that the magnets inside the plugs will repel the light-bar if not installed in the correct direction.

Repeat this step for each pendant.

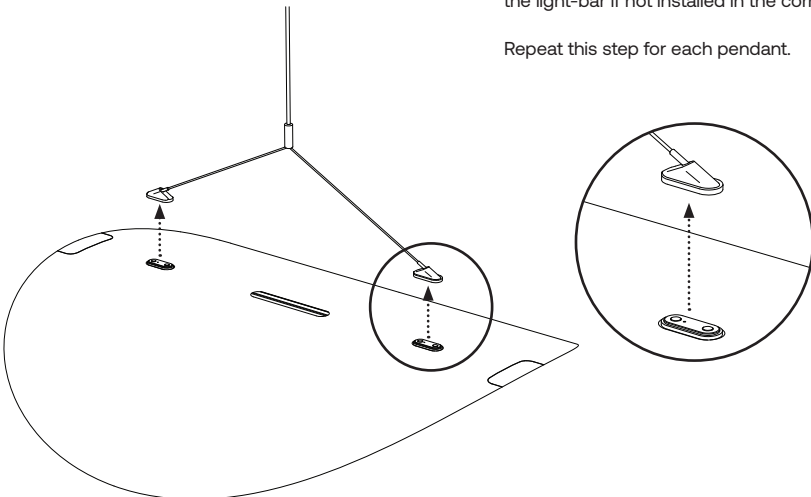

III. 22

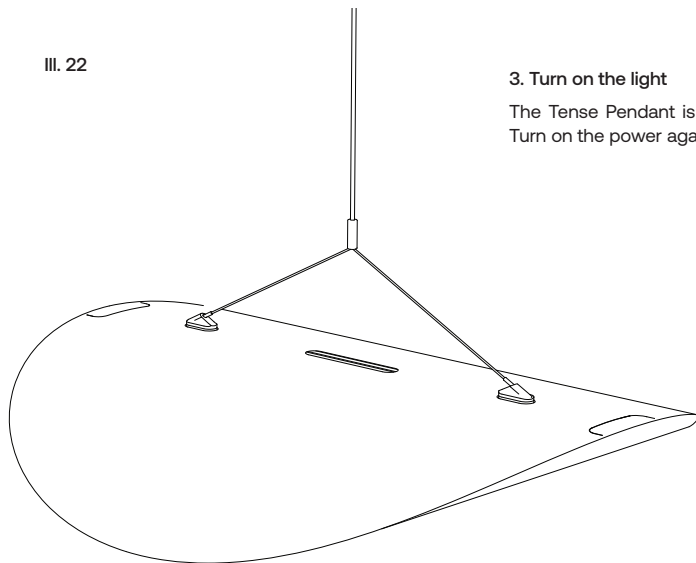

3. Turn on the light

The Tense Pendant is now assembled correctly.
Turn on the power again and test if lamp.

NEW WORKS.

info@newworks.dk +45 72 30 99 99

Frederiksgade 1, Ground Floor, 1265 Copenhagen, Denmark

www.newworks.dk @newworksdk