

# PH 5

The fixture provides a comfortable, glare-free light, based on the principle of Poul Henningsen's reflective three-shade system, which directs the majority of the light downwards. It emits a lateral light as well as illuminating itself, providing a soft radiance from within its core. The lower shade is furthermore fitted with a frosted diffuser glass to ensure that the downward directed light is 100% glare-free.

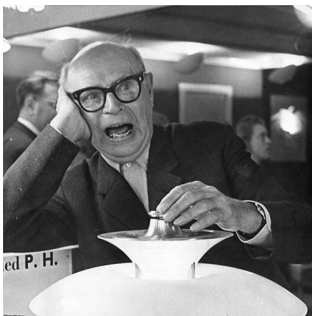

## Poul Henningsen

The very influential Danish designer, architect, writer, and cultural critic, Poul Henningsen (1894-1967), has had a huge impact on Danish thinking and design. His legacy is an integrated part of Louis Poulsen's endeavor to shape light.



## Restaurant Madsen



## Product info

### Environmental Product Specification

This product is compliant with the requirements contained in the European Directives, RoHS Directive 2011/65 and 2015/863. This product is designed so that 100% of the product can be disassembled and reused.

### Information

Colour of anti-glare disc: Blue: White Classic, Monochrome Blue and Hues of Orange. Green: Hues of Red and Hues of Rose. Red: Hues of Green and Hues of Blue. Rose: Pastel Blue Rose Peach, Hues of Grey and White Modern. Peach: Pastel Oyster Blue Rose. Same colour/material as main shade on Monochrome and Metal variants. Colour of struts: Purple: White Classic. Bronze coloured: White Modern and Hues of colours. White: Copper, Brass and Pastels. Same colour as main shade on Monochrome variants. Cable and canopy: Monochrome Black: Black cable and canopy. All others: White cable and canopy. Please note that the copper and brass surface is untreated. This means that the surface will change over time and develop a patina. This process may have already begun when the product is delivered.

### Mounting

Suspension type: Cable 2x1mm<sup>2</sup>. Canopy: Yes. Cable length: 3m.

### Finish

Matt powder coated or Matt wet painted. Powder coated: White Classic, White Modern and Metal finishes. Wet painted: Monochromes, Pastels and Hues Of finishes. Please note that the copper and brass surface is untreated. This means that the surface will change over time and develop a patina.

### Materials

Lower shade: Spun steel. Other shades and anti-glare disc: Spun aluminium, spun copper or spun brass. Struts: Rolled aluminium. Diffuser: Frosted glass.

### Sizes and weights

width x Height x Length (mm) | 500 x 267 x 500 Max 3.5 kg

### Class

Ingress protection IP20. Electric shock protection II w/o ground.

### Specification notes

The innovation of light sources is ongoing. Consequently we only inform about the max. wattages. On [www.louispoulsen.com](http://www.louispoulsen.com) we update a list of recommendable light sources.

### Light source

1x75W E27

### Information

Colour of anti-glare disc:

Blue: White Classic, Monochrome Blue and Hues of Orange.

Green: Hues of Red and Hues of Rose.

Red: Hues of Green and Hues of Blue.

Rose: Pastel Blue Rose Peach, Hues of Grey and White Modern.

Peach: Pastel Oyster Blue Rose.

Same colour/material as main shade on Monochrome and Metal variants.

Colour of struts:

Purple: White Classic.

Bronze coloured: White Modern and Hues of colours.

White: Copper, Brass and Pastels.

Same colour as main shade on Monochrome variants.

Cable and canopy:

Monochrome Black: Black cable and canopy.

All others: White cable and canopy.

Please note that the copper and brass surface is untreated. This means that the surface will change over time and develop a patina. This process may have already begun when the product is delivered.



## Related products

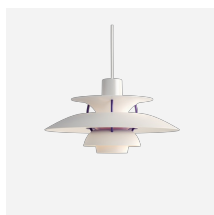

PH 5 Mini























PH 5 Retake



PH 5 Anniversary Edition

## Product variants

Colour	Cable type	Light source	Class
 Brass	Black fabric cord	1x75W E27	-
 Copper	White fabric cord		II
 Hues of blue			
 Hues of green			
 Hues of grey			
 Hues of orange			
 Hues of red			
 Hues of rose			
 Monochrome black			
 Monochrome blue			
 Monochrome burgundy			
 Monochrome dusty indigo			
 Monochrome oyster grey			
 Monochrome pale blush			
 Monochrome pale pewter			
 Monochrome pale rose			
 Monochrome white			
 Pastels blue rose peach			
 Pastels oyster blue rose			
 White classic			
 White modern			

# Product description

Suspended shade luminaire  
4 shades ensures minimal direct view of lamp  
Geometry created to ensure illumination of large rooms  
Iconic design  
Family of two dimensions  
Top shade to hide insert

---

## Mounting

Can be mounted on 4" octagonal junction box. (USA only)  
Relamping by removing bottom-center glare shield held in place with spring-loaded tabs.

---

## Light description

Spherical light distribution  
Top trumpet shaped shade provides vertical illumination of room  
Three lower primarily directs light down  
Internal reflector and bottom glass shield protect against glare  
Geometry ensures uniform light around the fixture  
Matte painted undersurfaces of shades creating uniform light distribution around the fixture

---

## Design

Poul Henningsen

---

## Material

Shades: Spun aluminum, 0.8 mm (0.03") thick.  
On PH5 White and PH50 variants: red interior adds warmth to light.  
Internal struts of matte chrome plated aluminum.  
Socket: Porcelain, medium base, for A-23 clear envelope lamps.  
Socket position is adjustable to allow correct lamp position and fixture illumination.  
Canopy: 5.3" diameter x 0.9" tall cone of spun aluminum.  
Cable: white PVC coated, 12 ft. (USA)

---

## Weight

Min: 2.003 kg Max: 3.483 kg

---

## Finish

Brass, Copper, Hues of blue, Hues of green, Hues of grey, Hues of orange, Hues of red, Hues of rose, Monochrome black, Monochrome blue, Monochrome burgundy, Monochrome dusty indigo, Monochrome oyster grey, Monochrome pale blush, Monochrome pale pewter, Monochrome pale rose, Monochrome white, Pastels blue rose peach, Pastels oyster blue rose, White classic, White modern

# Light distribution diagrams

Cartesian

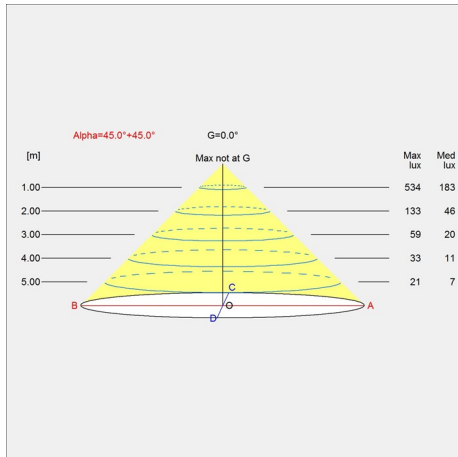

Isolux

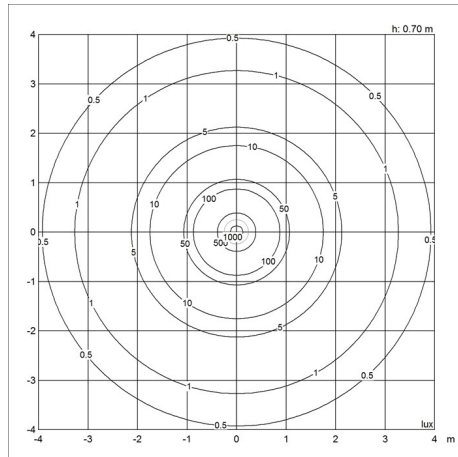

Polar

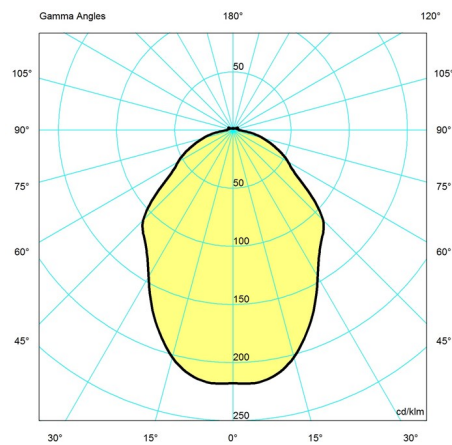

## Spare parts & accessories

Product

- PH 5 electrical assembly white f/old
- PH 5 glass disc
- Extension nipple f/stand. suspen
- PH 5 red/blue 100W inc bottom plate
- PH 5 Purple spacers
- PH 5 Bronze spacers
- Relief nipple white
- PH 5 Alu spacers
- PH 5 white matt electrical assembly
- PH 5 electrical assembly (EU)
- PH 5 White spacers
- PH 5 Monochrome White spacers
- PH 5 Monochrome Blue spacers
- PH 5 Monochrome Black spacers
- Canopy Black 2-part tophat®
- Canopy White 2-part tophat ®

Variant number

- 5741086498
- 5741093300
- 5741480670
- 5741481394
- 5741093407
- 5741100235
- 5741481268
- 5741100015
- 5741086443
- 5741099948
- 5741100248
- 5741106093
- 5741106103
- 5741106116
- 5749329021
- 5749329034