

PANTHELLA 400 TABLE LAMP

PantheLLa 400 Table Lamp - 5744167042

The fixture emits a glare-free, soft and comfortable illumination. The opal acrylic shade leaves a diffused comfortable light atmosphere due to the translucent shade, the downward reflection from the inner shade and the reflection from the trumpet stem.

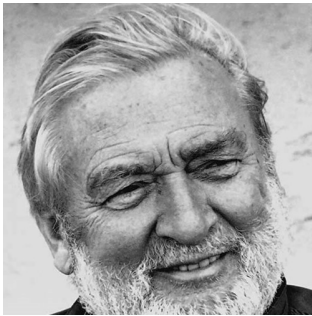

Verner Panton

Verner Panton (1926-1998) is famous for his inspirational and colorful personality. A unique person with a special sense for color, shape, light function and space. Over the course of his career, Panton introduced a series of modern lamps with personalities unlike any of his Scandinavian contemporaries.

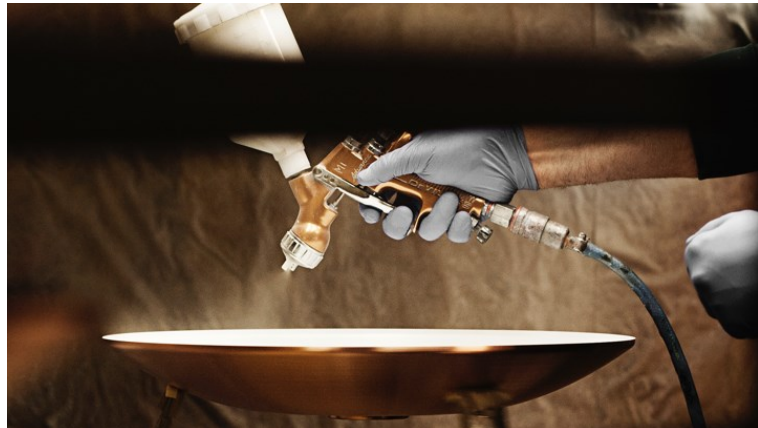

Product info

Mounting

Cable type: Plastic cord with plug. Cable length: 2.5m. Light control: On/off switch on cord. Diffuser with bajonet lock.

Finish

White opal acrylic.

Materials

Shade: Injection moulded white opal acrylic. Base: White, injection moulded ABS. Housing: White, injection moulded ABS. Stem: White, steel. Diffuser : Injection moulded opal pmma.

Sizes and weights

Width x Height x Length (mm) | 400 x 550 x 400 Max 2.5 kg

Class

Ingress protection IP20. Electric shock protection II.

Specification notes

The innovation of light sources is ongoing. Consequently we only inform about the max. wattages. On www.louispoulsen.com we update a list of recommendable light sources.

Light source

1x28W E27



Related products



Panthella Floor

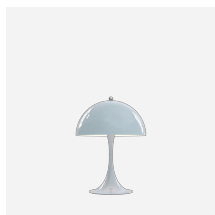

Panthella 250 Table Lamp

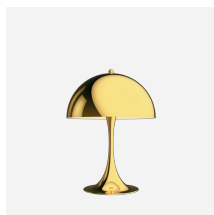

Panthella 320 Table Lamp

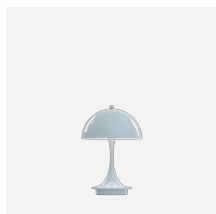

Panthella 160 Portable

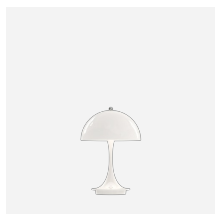

Panthella 160 Portable Metal

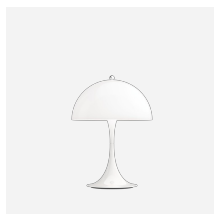

Panthella 250 Portable

Light distribution diagrams

Cartesian

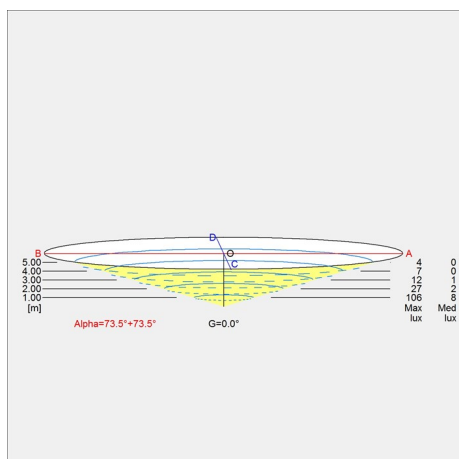

Isolux

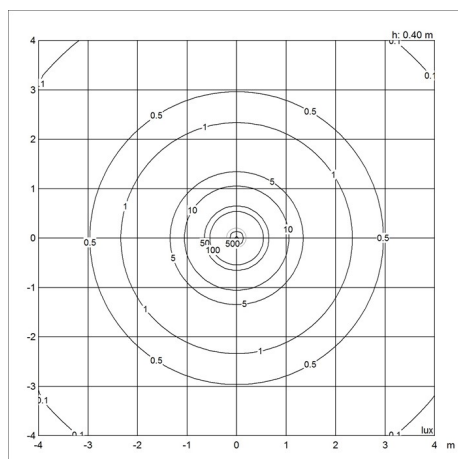

Polar

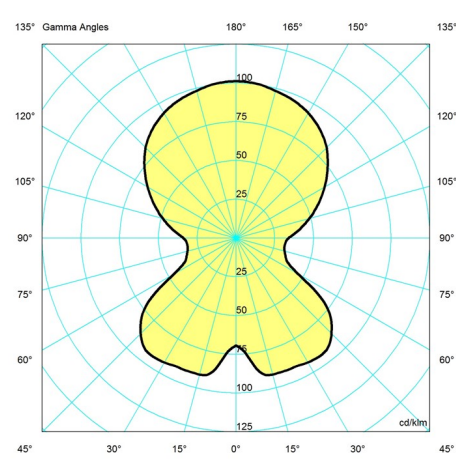

Spare parts & accessories

Product

Panthella Floor/400 chrome nut
 Panthella 400 shade holder clear
 Panthella 400 diffuser V2021
 Panthella 400 bajonetbase V2021
 Panthella 400 shade

Variant number

5744610049
 5744610544
 5744167479
 5744167482
 5744167505

Data specifications

Colour	White opal acryl	Length	400
Width	400	Height	550
Built-in Height	-	IP class	20
Class	II	Net Weight	2.5
Standby (W)	-	Power Factor (P = 100 % / P = 50 %)	-
Inrush Current	-	Light source	1x28W E27

Panthea 400 Table Lamp

Kelvin	-
SDCM	-
Watt	-
Light control	-
UGR Transversal / Axial	10.2/10.2
Driver life	-

CRI	-
Lumen	-
Efficacy	-
Min. Dim Level (%)	-
L80B50 (hours)	-