

Pond Cafe Table

Assembly manual

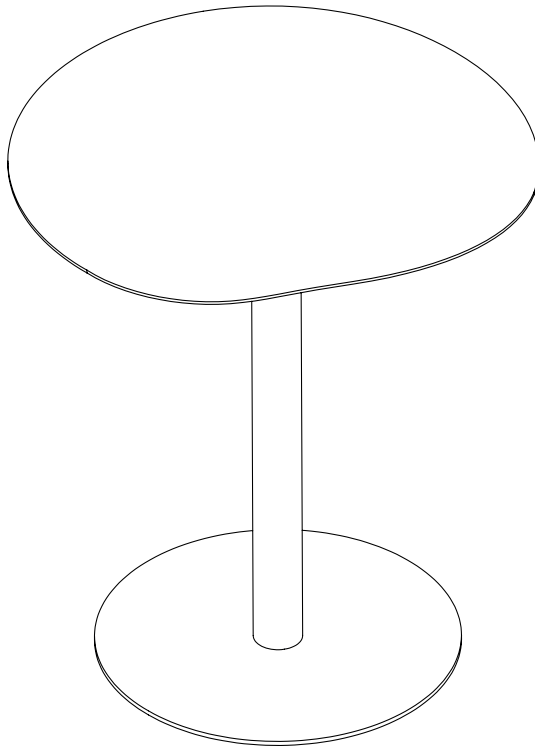

ferm
L I V I N G

General Instructions

PLEASE READ BEFORE INSTALLATION

WARNING:

The safety of this fitting can only be guaranteed if the following instructions are observed during both installation and use. Please retain these instructions safely after installation.

PLEASE OBSERVE THE FOLLOWING GUIDELINES:

- Ensure that all screws are firmly tightened before using the table.
- This table is made from powder coated galvanized structural steel to give an anti-rust surface.
- If the anti-rust surface is damaged, the table will start to rust.
- Be aware, prolonged outdoor use and exposure to the elements will cause rusting over time.
We therefore advise that you bring your table inside during cold weather – particularly if the temperature drops below freezing.

CLEANING INSTRUCTIONS:

- Gently wipe with soft damp cloth with water and mild soap if needed.

MORE INFORMATION:

To access further information such as product overview and material descriptions, please visit our website at www.fermliving.com. If you have any questions or comments, please do not hesitate to contact us at info@fermliving.com.

Box Content

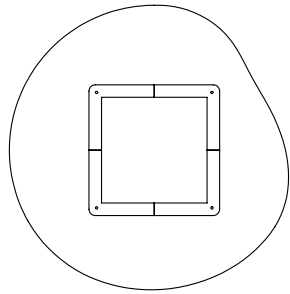

1x
Table top

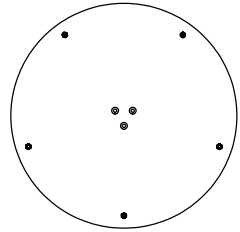

1x
Table base

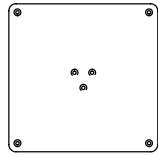

1x
Connection plate

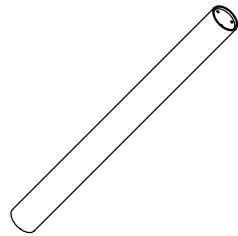

1x
Column



6x
A) Counter Sunk Screw



4x
B) Counter Sunk Screw



1x
Allen key

Assembly Process

1

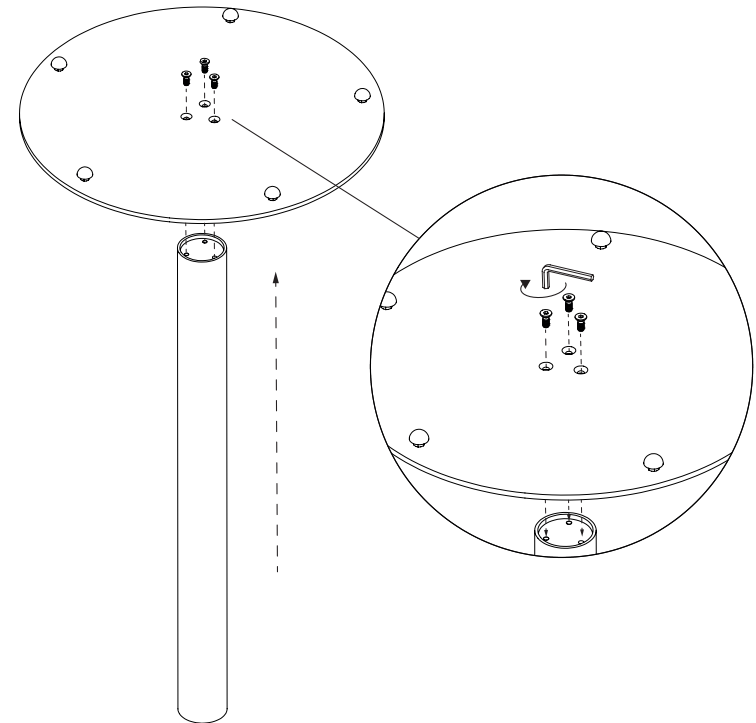

Mount the table base on the column with 3 (A) counter sunk screws.

Assembly Process

2

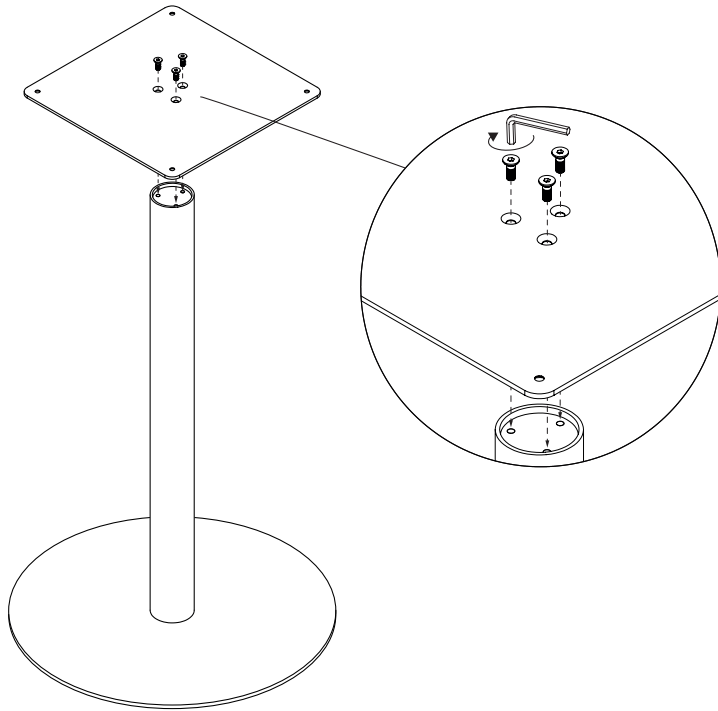

Mount the Connection plate on the column with 3 (A) counter sunk screws.

Assembly Process

3

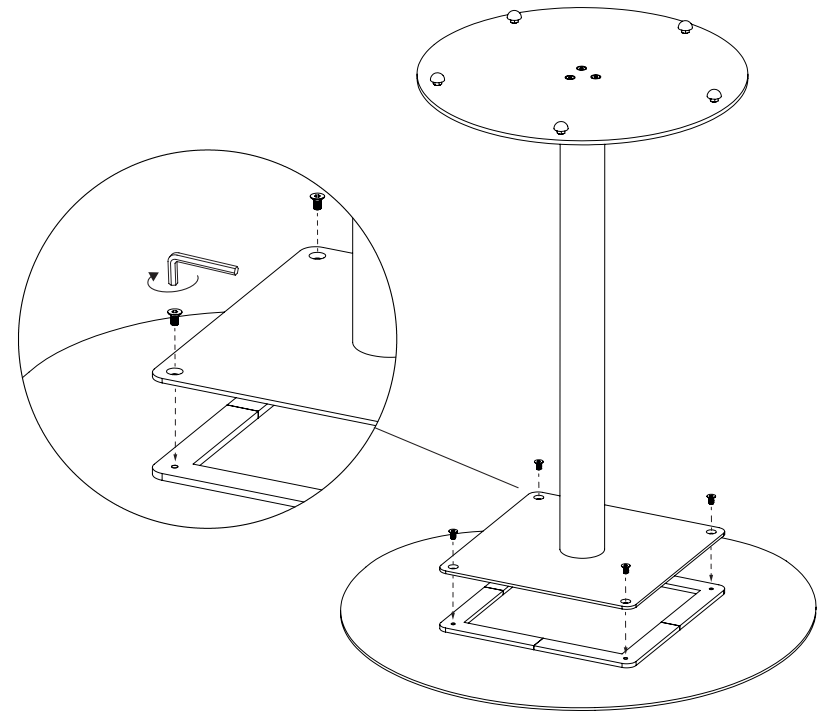

Lay the table top on a blanket and mount the table leg with 4 (B) counter sunk screws.

fermliving.com