

TIPTOE

Technical manual



TIPTOE TABLE LEGS 75CM - OUTDOOR

TIPTOE TABLE LEGS 75 CM OUTDOOR

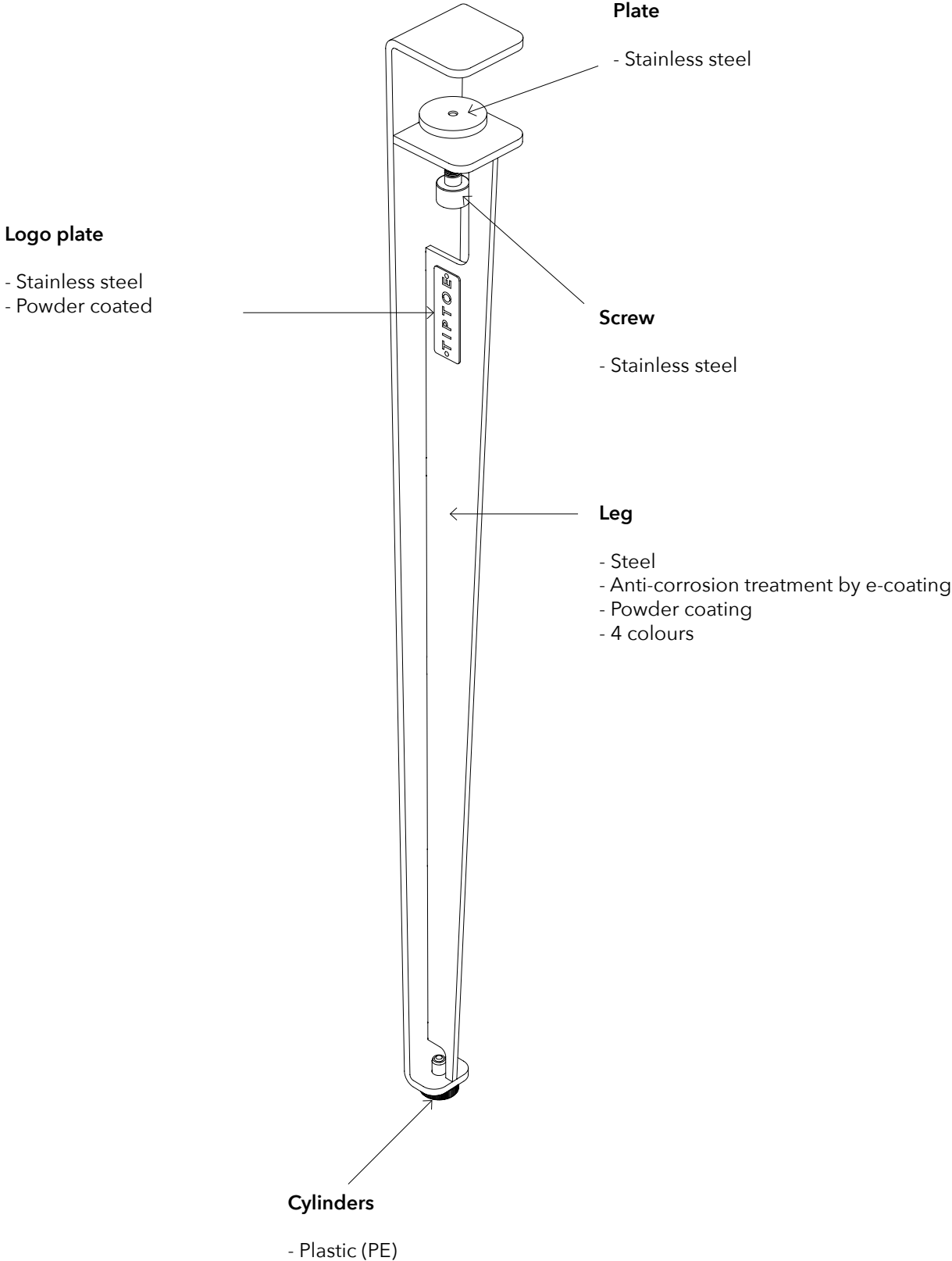

TIPTOE TABLE LEGS 75 CM OUTDOOR - 2023

TIPTOE expresses its values of sustainability outdoors with its first outdoor range: MIDI. The collection has been entirely designed with quality materials and manufactured 100% in Europe (Lithuania and France).

MIDI table from TIPTOE takes up the brand's iconic object: the tight table leg. With its dimensions of 160x80 and 190x90, the garden table can accommodate up to 6 to 8 people. The table top is made of perforated steel with a e-coating anti-corrosion treatment to ensure its longevity. The leg screws are made of stainless steel and developed to resist corrosion.

MIDI range is accompanied by the SSDr outdoor chair collection. These chairs, part of the SSD range, have a seat and backrest made of recycled post-consumer polypropylene. A plastic with a wide range of industrial applications: food containers, car parts or household appliances. The chair's legs are made of steel, a material that is both very resistant and infinitely recyclable. For its outdoor version, the SSDr chair has been given an anti-UV treatment to prevent colour variations.

The table and chairs are available in various timeless colours such as graphite black, chalk grey, forest green and also bright colours such as sunshine yellow. The collection can be easily integrated in your garden, but also in professional spaces like a café or a restaurant.

ORIGINS

Lituania (Screws, Stainless Steel plate and Legs)

SPECIFICATIONS

Anti-corrosion treatment by e-coating



This product is designed for outdoor use.

TIPTOE TABLE LEGS 75 CM OUTDOOR - COLOURS AND FINISHES

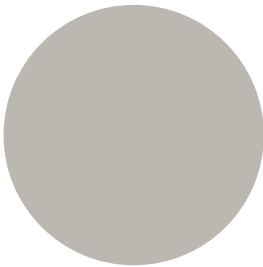

CHALK GREY - RAL 7044

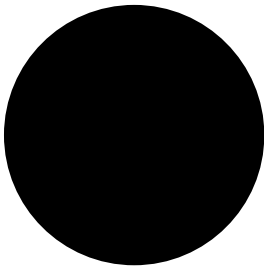

GRAPHIT BLACK - RAL 9011

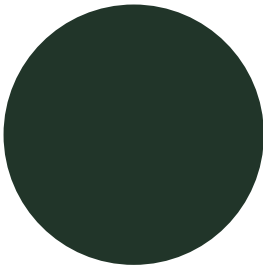

FOREST GREEN - RAL 6009

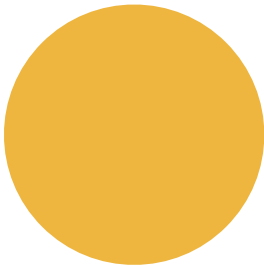

SUN YELLOW - RAL 1023

TIPTOE TABLE LEGS 75 CM OUTDOOR - RECOMMANDATIONS

Table top thickness

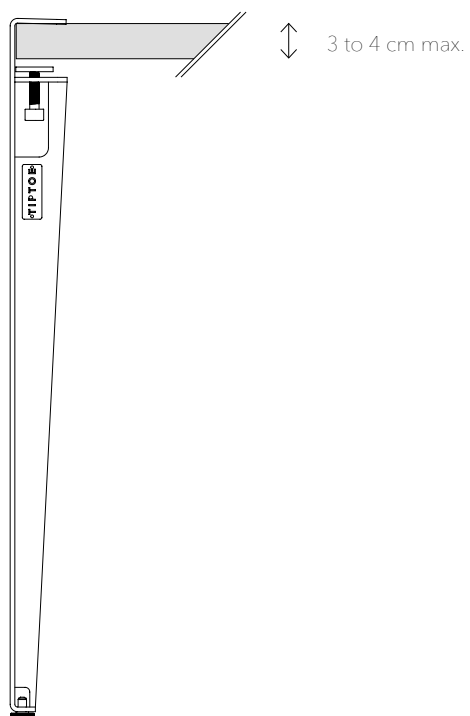

Use

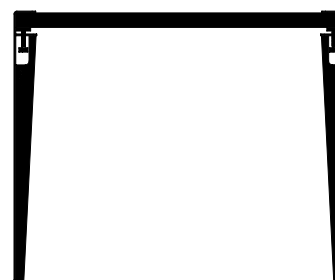

Outdoor

Max. dimensions for 4 legs 75 cm outdoor

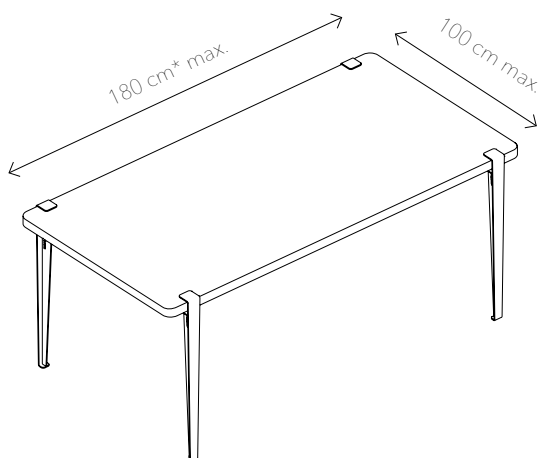

Max. weight for 4 legs 75 cm outdoor

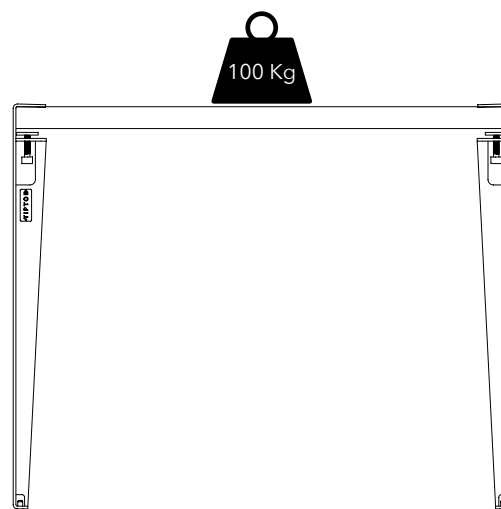

* Over 150 cm, use a 4 cm thick table top.

PIED 75 CM OUTDOOR - DIMENSIONS

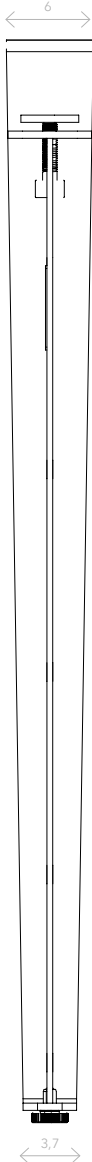
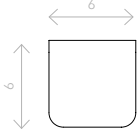

Weight : 2,5Kg