

# TIPTOE

Technical Manual

TABLE LEG 43 CM

TABLE LEG 43 CM

---

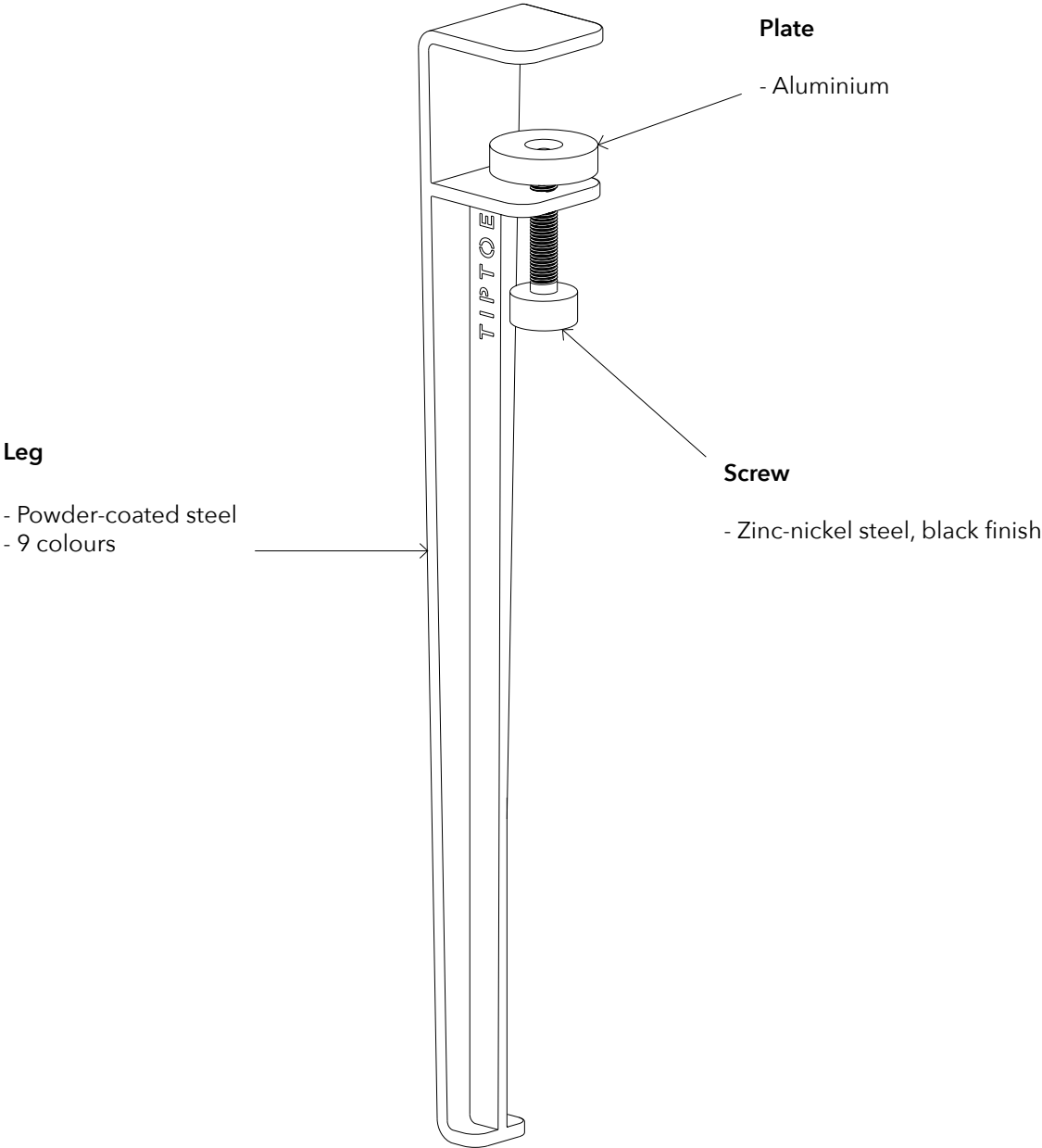

PIED 43 CM - COLOURS AND FINISHES

---

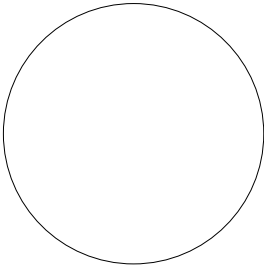

CLOUDY WHITE - RAL 9010

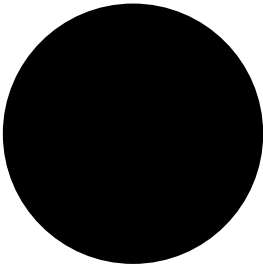

GRAPHITE BLACK - RAL 9011

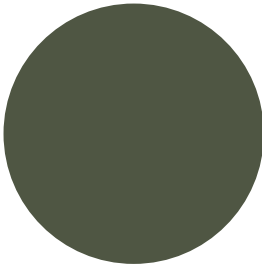

ROSEMARY GREEN - RAL 6003

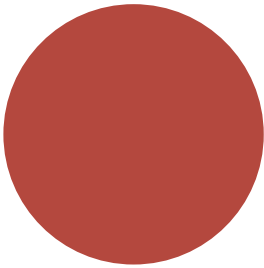

TERRACOTTA RED - RAL 3016

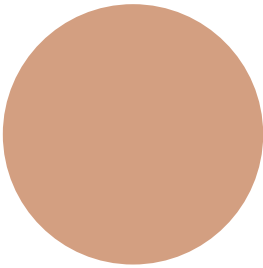

ASH PINK - RAL 3012

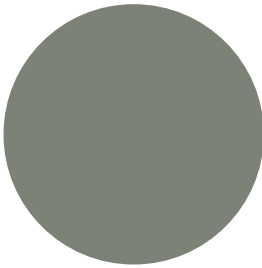

EUCALYPTUS GREY - RAL 7003

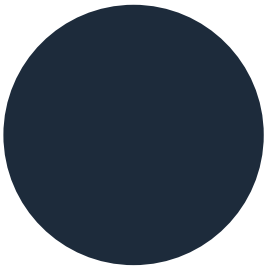

MINERAL BLUE - RAL 5011

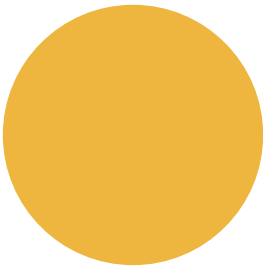

SUNFLOWER YELLOW - RAL 1003



DARK STEEL

# PIED 43 CM - RECOMMANDATIONS

## Table top thickness

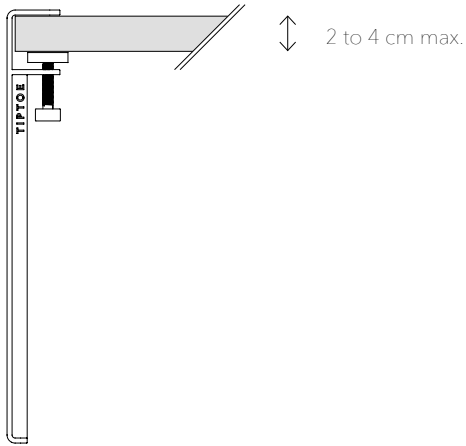

## Application

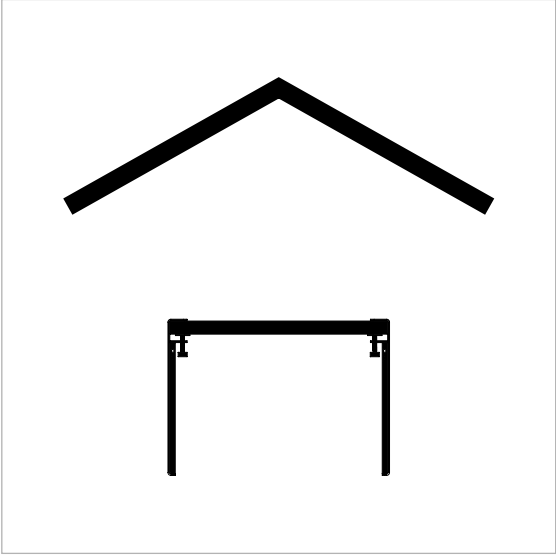

Indoor

## Max. dimensions for 4 legs 43 cm

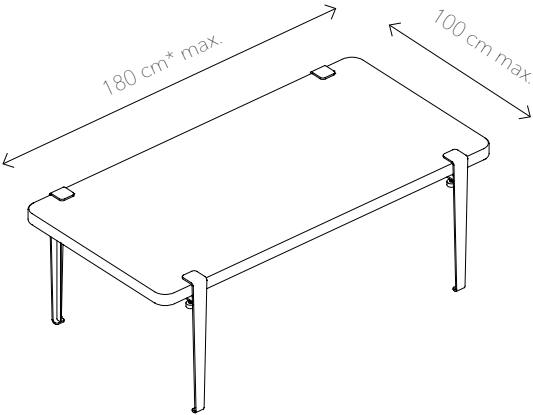

## Max. weight for 4 legs 43 cm

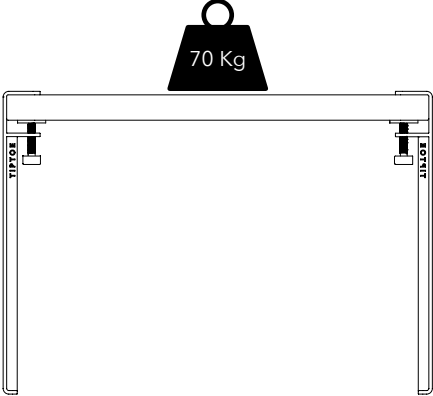

\* Over 150 cm, use a 4 cm thick table top.

TABLE LEG 43 CM - DIMENSIONS

---

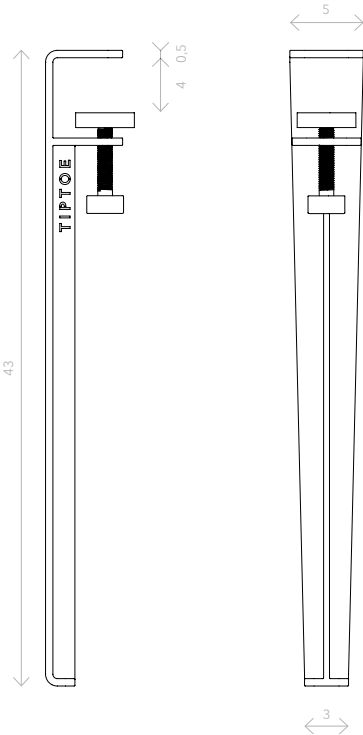
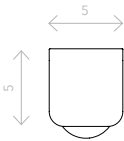

# TIPTOE

Technical Manual



TABLE LEG 75 CM

TABLE LEG 75 CM

---

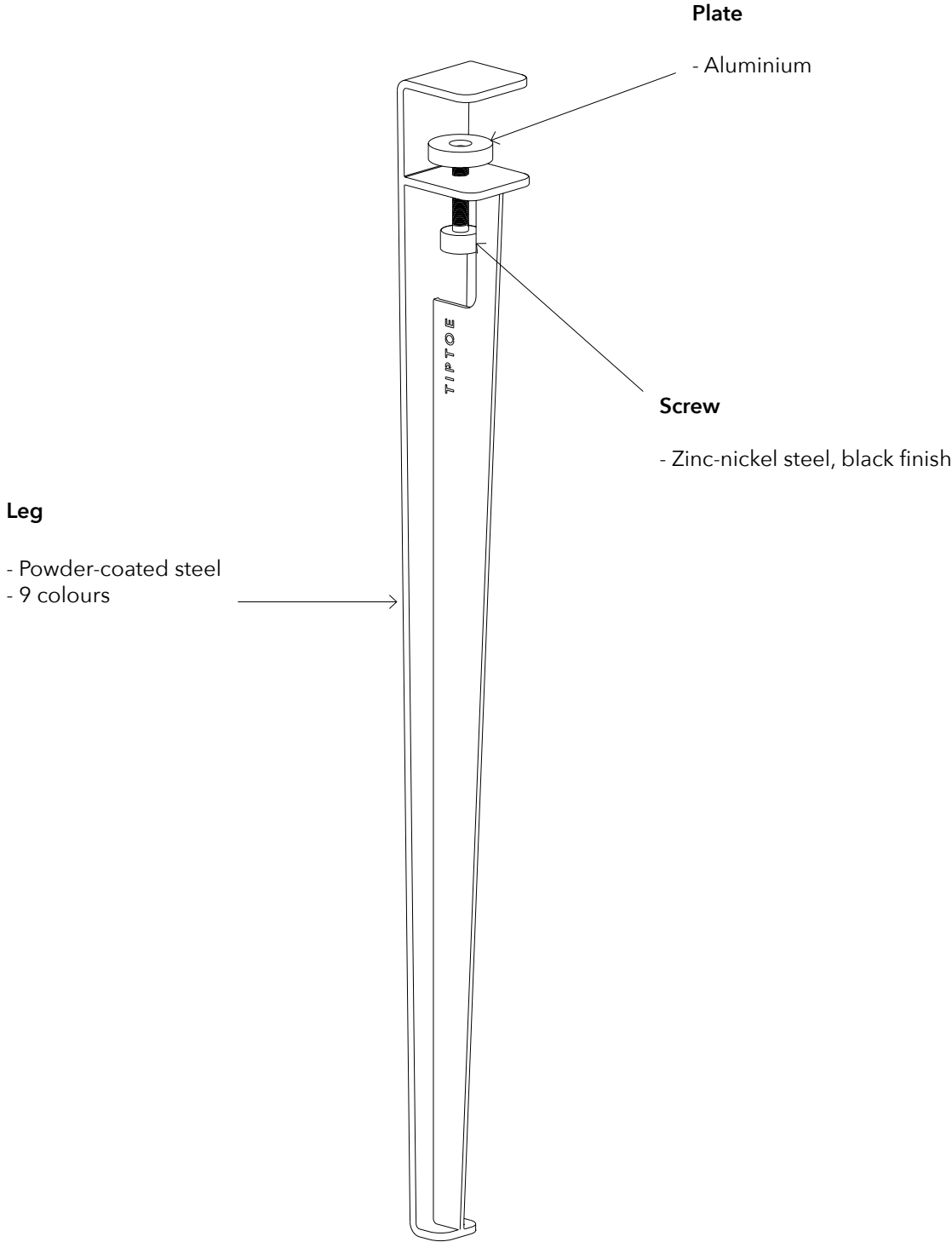

# TABLE LEG 75 CM - COLOURS AND FINISHES

---

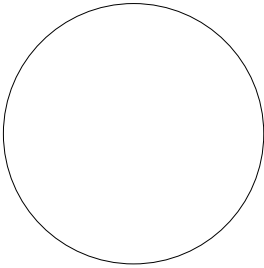

CLOUDY WHITE - RAL 9010

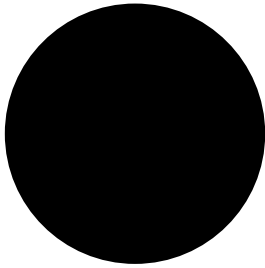

GRAPHITE BLACK - RAL 9011

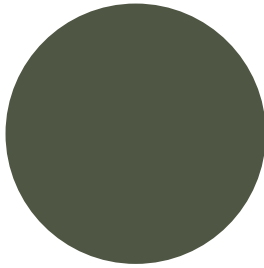

ROSEMARY GREEN - RAL 6003

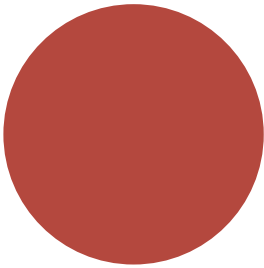

TERRACOTTA RED - RAL 3016

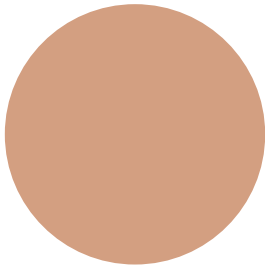

ASH PINK - RAL 3012

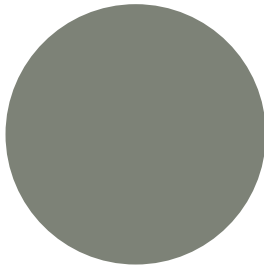

EUCALYPTUS GREY - RAL 7003

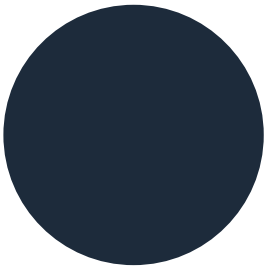

MINERAL BLUE - RAL 5011

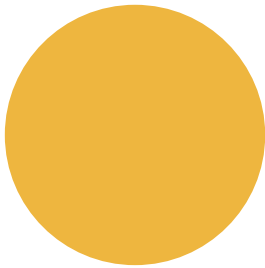

SUNFLOWER YELLOW - RAL 1003

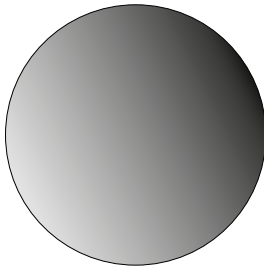

DARK STEEL



# TABLE LEG 75 CM - RECOMMANDATIONS

## Table top thickness

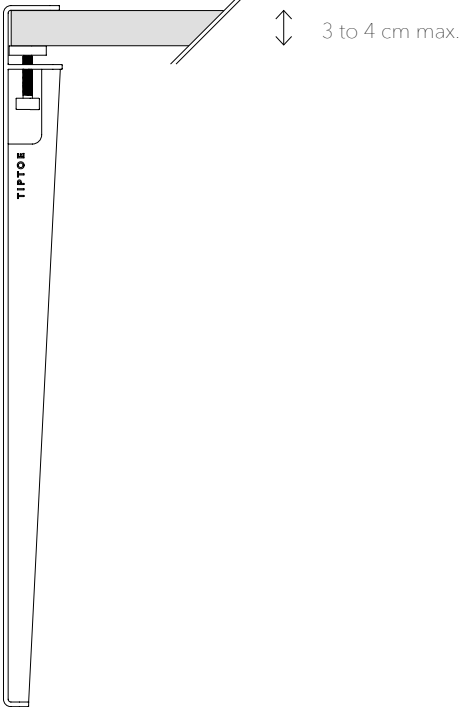

## Application

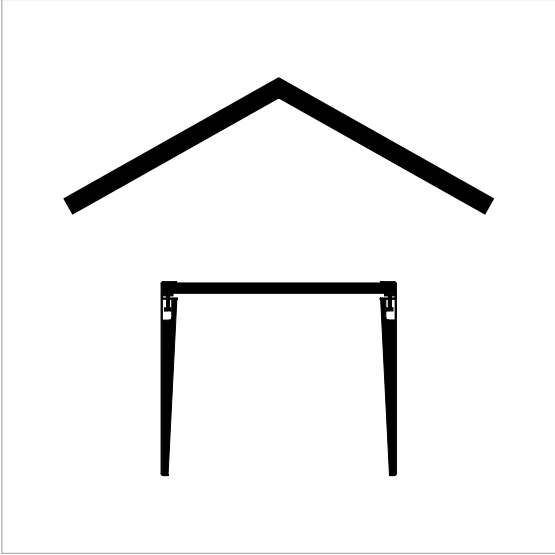

Indoor

## Max. dimensions for 4 legs 75 cm

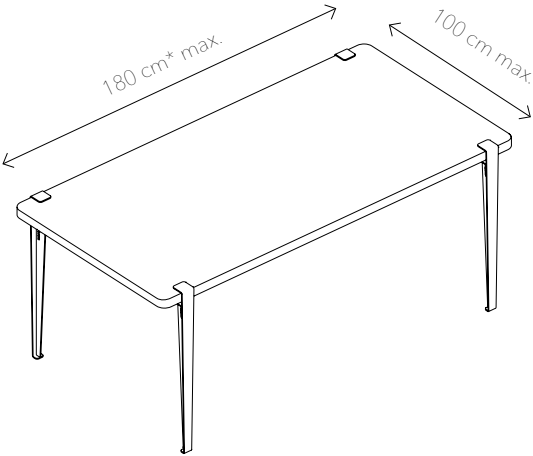

## Max. weight for 4 legs 75 cm

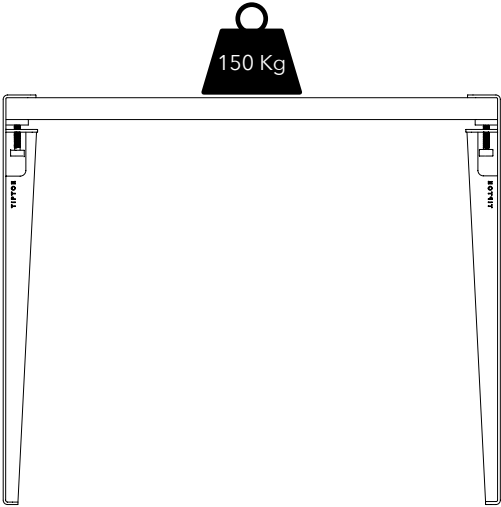

\* Over 150 cm, use a 4 cm thick table top.

# TABLE LEG 75 CM - DIMENSIONS

---

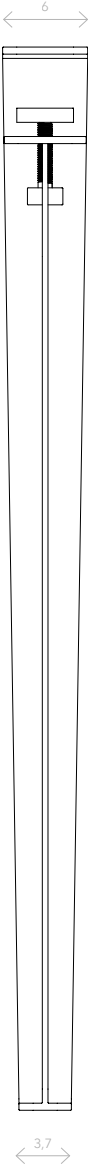
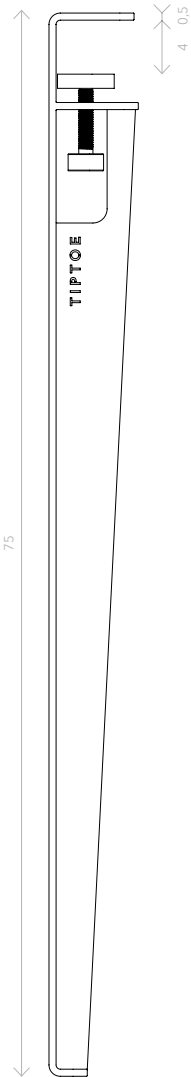
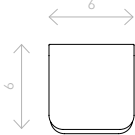

# TIPTOE

Technical Manual



TABLE LEG 90 CM

TABLE LEG 90 CM

---

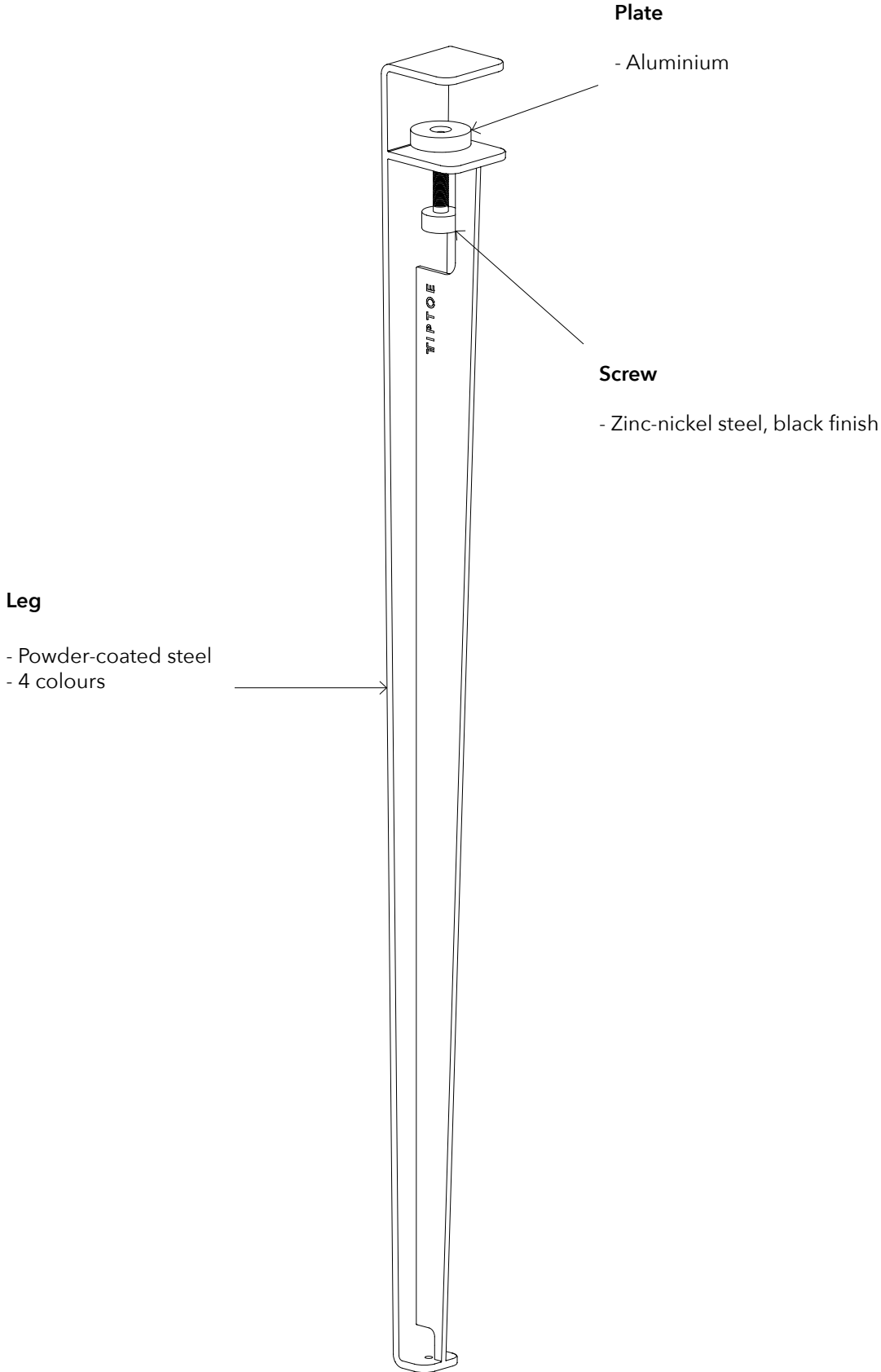
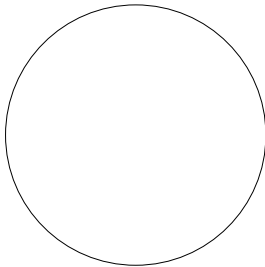
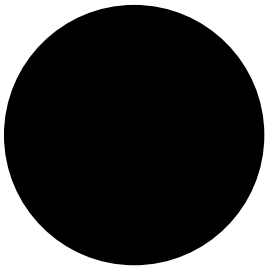

TABLE LEG 90 CM - COLOURS AND FINISHES

---



CLOUDY WHITE - RAL 9010



GRAPHITE BLACK - RAL 9011

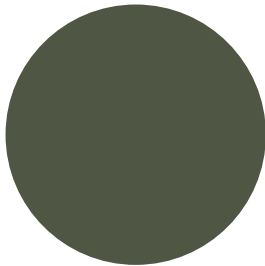

ROSEMARY GREEN - RAL 6003

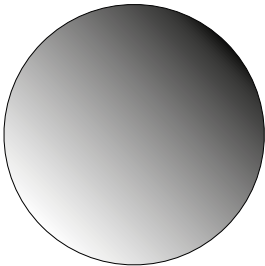

DARK STEEL

# TABLE LEG 90 CM - RECOMMANDATIONS

## Table top thickness

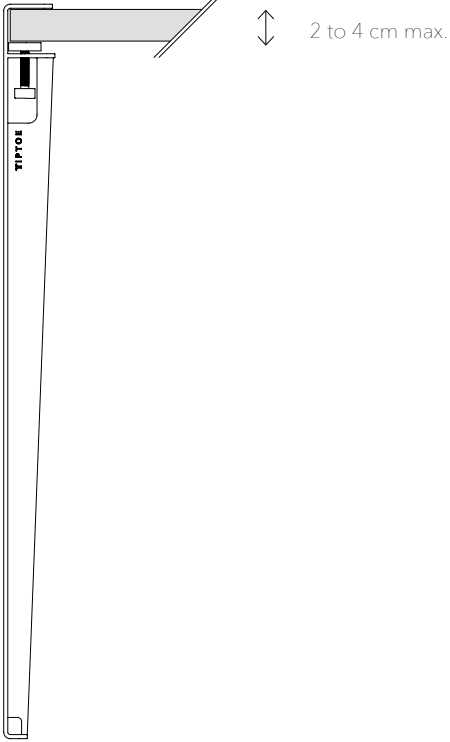

## Application



Indoor

## Max. dimensions for 2 legs 90 cm & 2 brackets

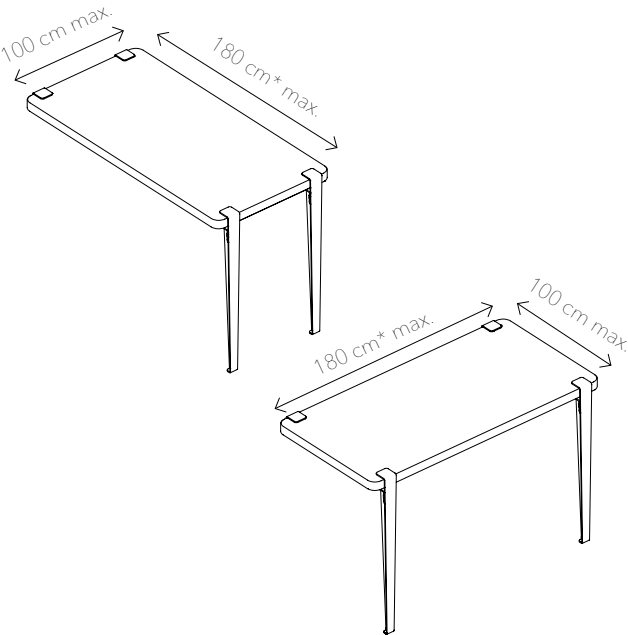

## Max. weight for 2 legs 90 cm & 2 brackets

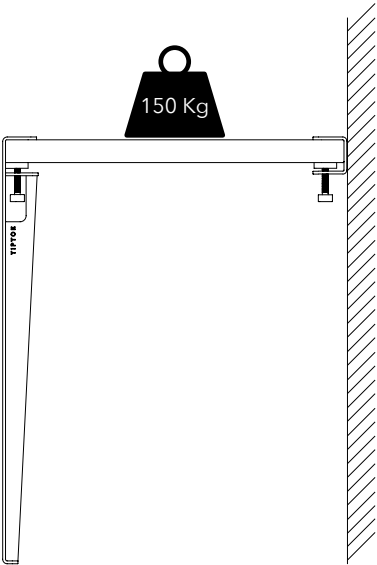

\* Over 150 cm, use a 4 cm thick table top.

# TABLE LEG 90 CM - DIMENSIONS

---

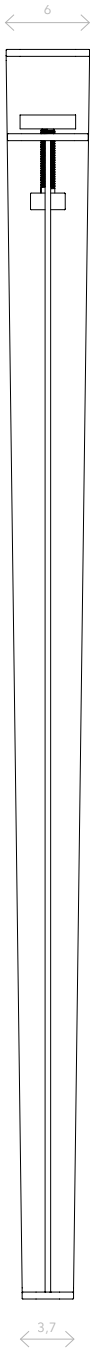
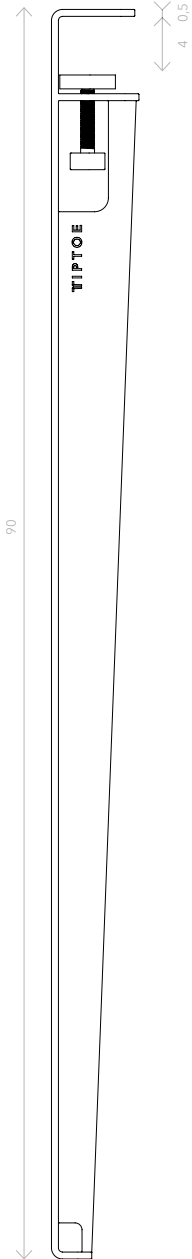
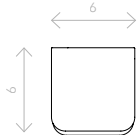



# TIPTOE

Technical Manual



TABLE LEG 110 CM



TABLE LEG 110 CM

---

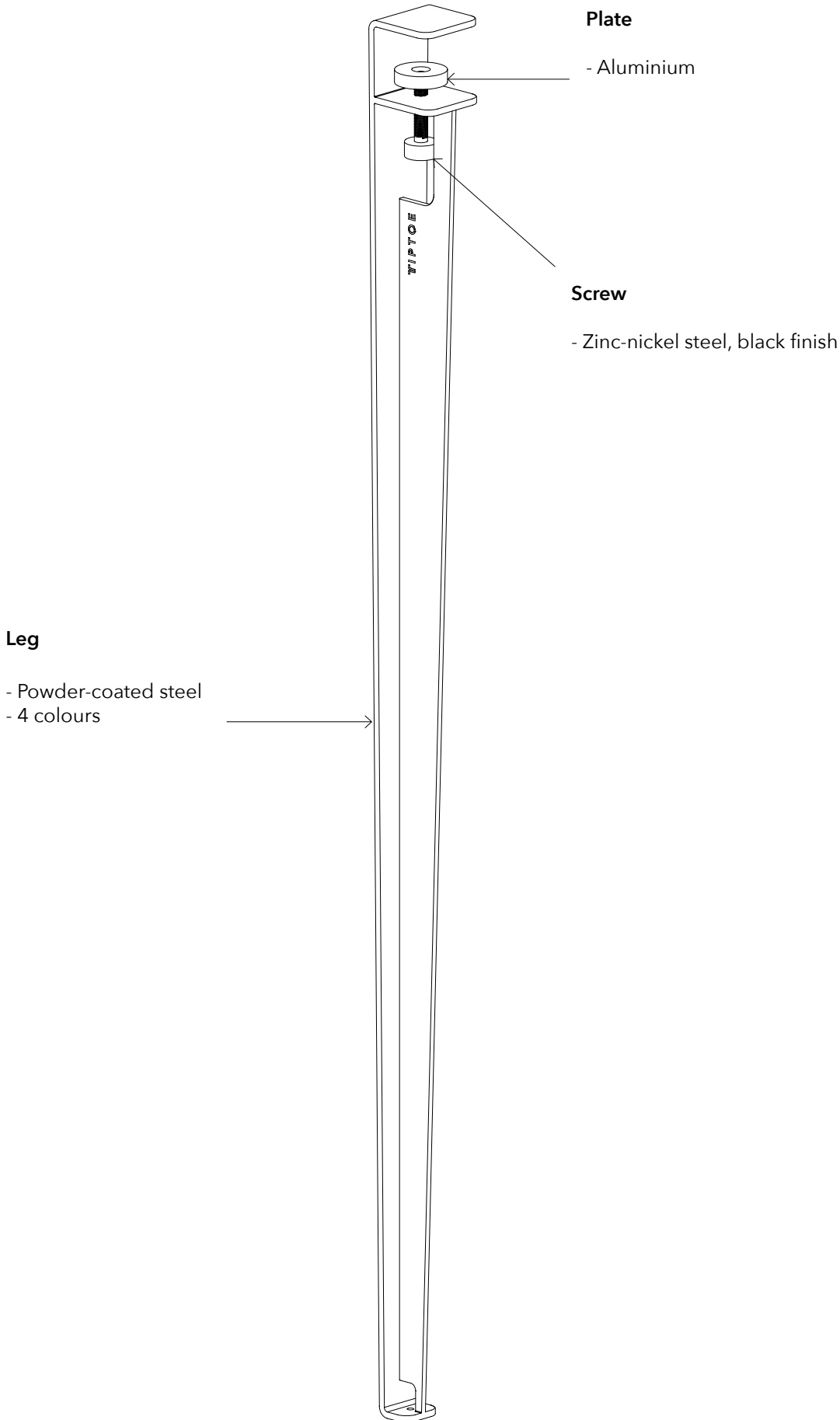
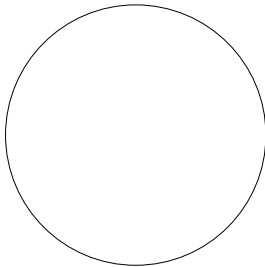
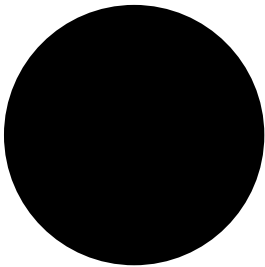

TABLE LEG 110 CM - COLOURS AND FINISHES

---



CLOUDY WHITE - RAL 9010



GRAPHITE BLACK - RAL 9011

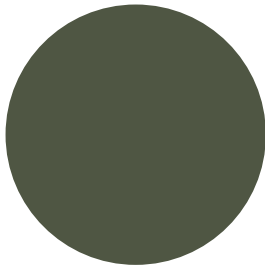

ROSEMARY GREEN - RAL 6003

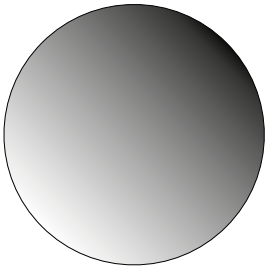

DARK STEEL

# TABLE LEG 110 CM - RECOMMANDATIONS

## Table top thickness

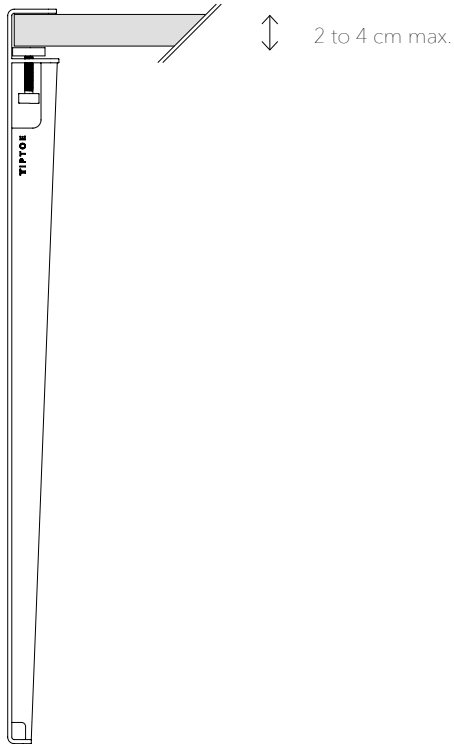

## Application



Indoor

## Max. dimensions for 2 legs 110 cm & 2 brackets

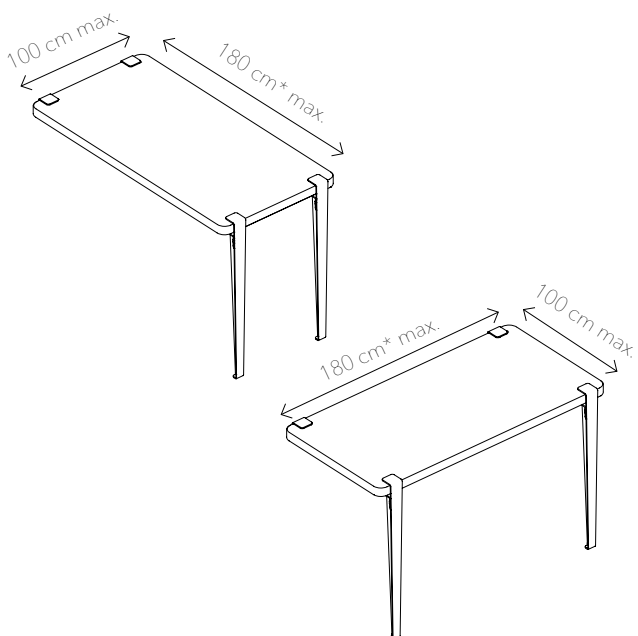

## Max. weight for 2 legs 110 cm & 2 brackets

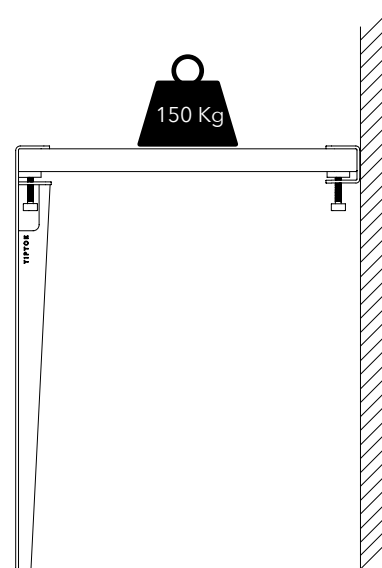

\* Over 150 cm, use a 4 cm thick table top.

# TABLE LEG 110 CM - DIMENSIONS

---

