

Artemide®

Callimaco led

design
E. Sottsass Jr.

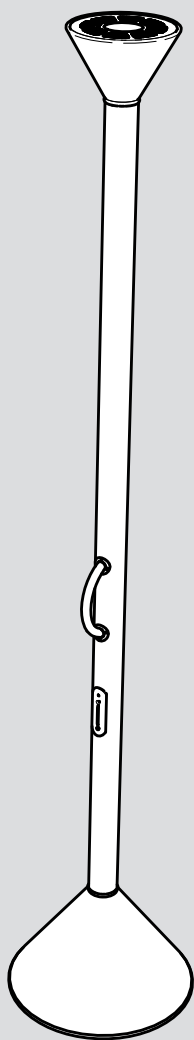



i

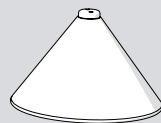
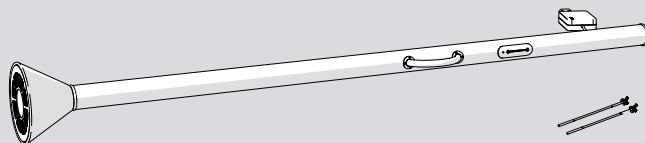
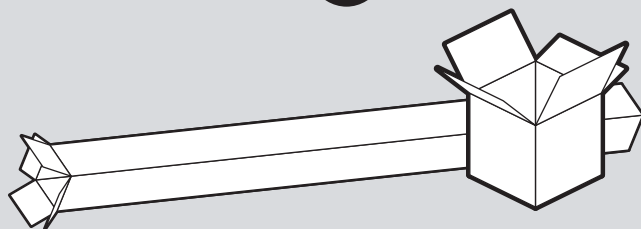
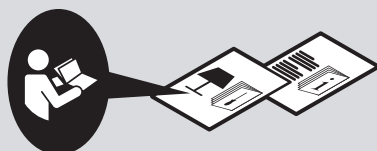
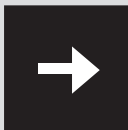
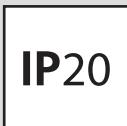
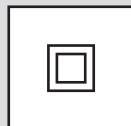

1

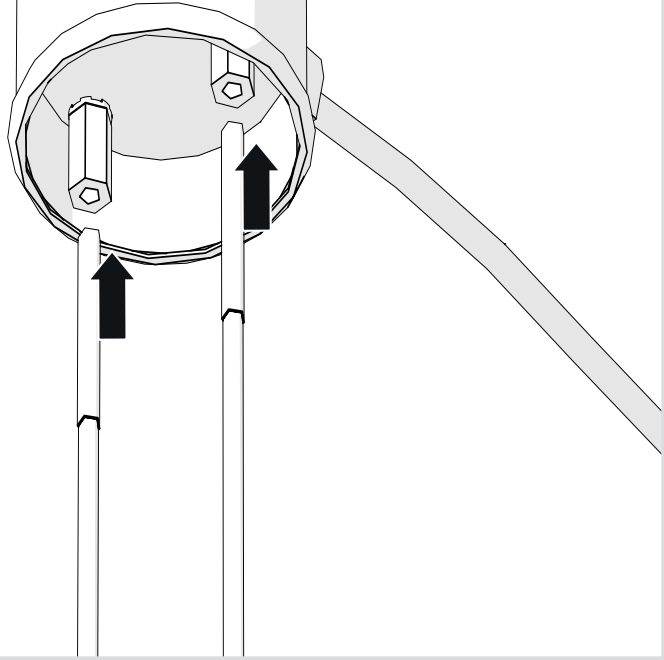

2

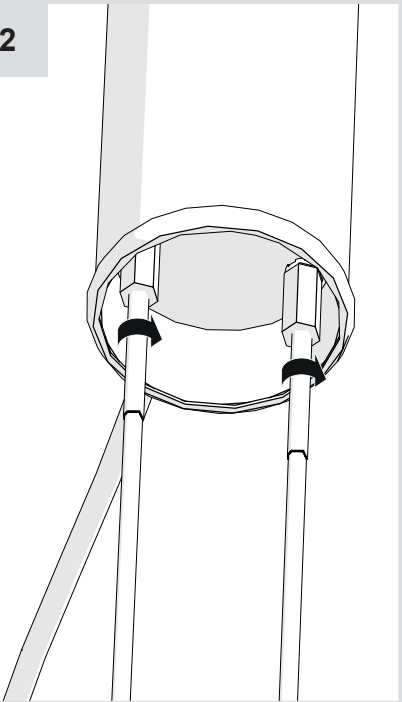

3

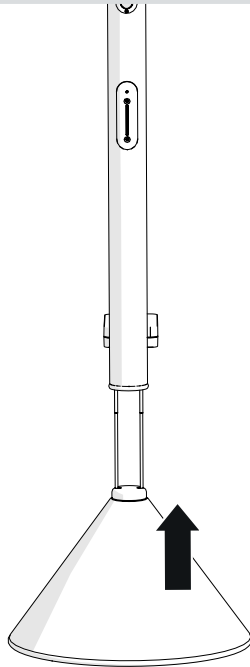

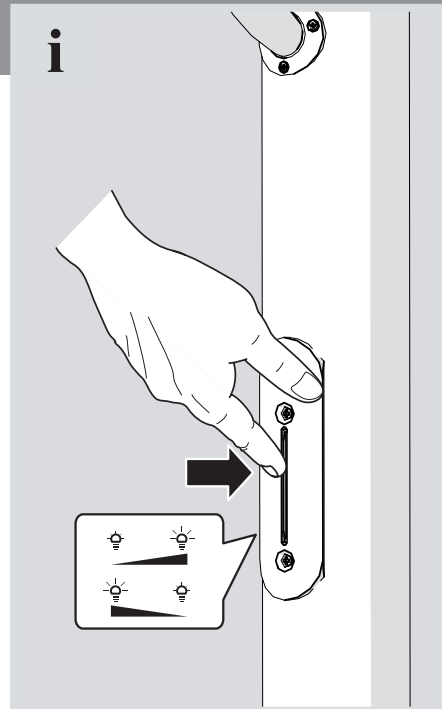
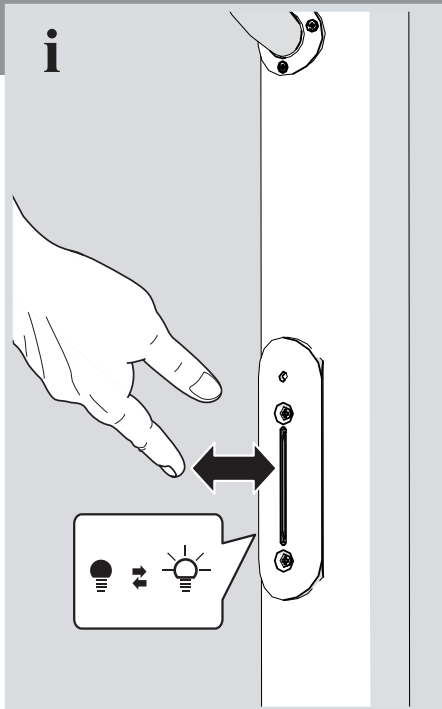
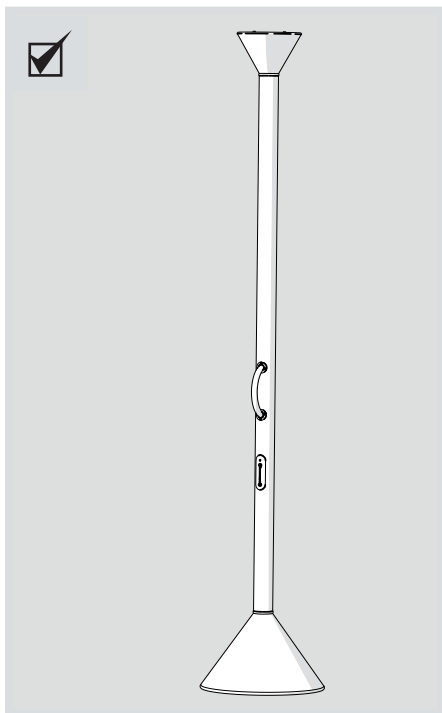
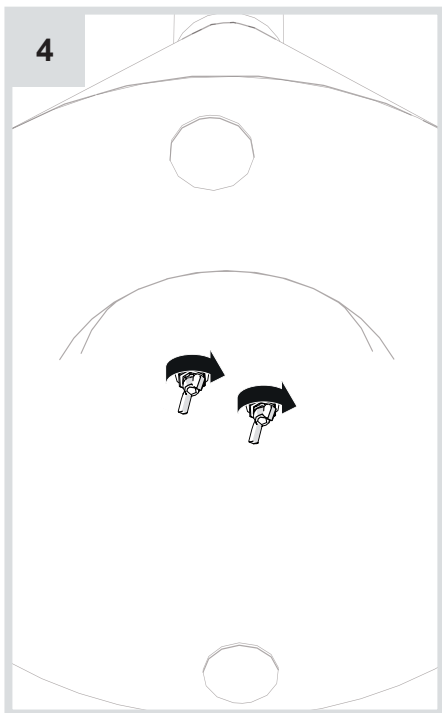



i

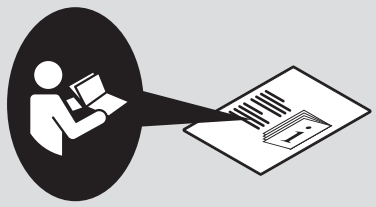

Artemide®

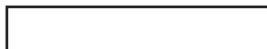

Artemide

via Bergamo, 18
20010 Pregnana M.se (MI)
ITALIA

tel. +39 02 935 181
fax +39 02 935 90 254
fax +39 02 935 90 496

www.artemide.com

VAT IT00846890150

cod. Y513000162A