

# Artemide®

## Empatia 16

design

C. de Bevilacqua - P. di Arianello

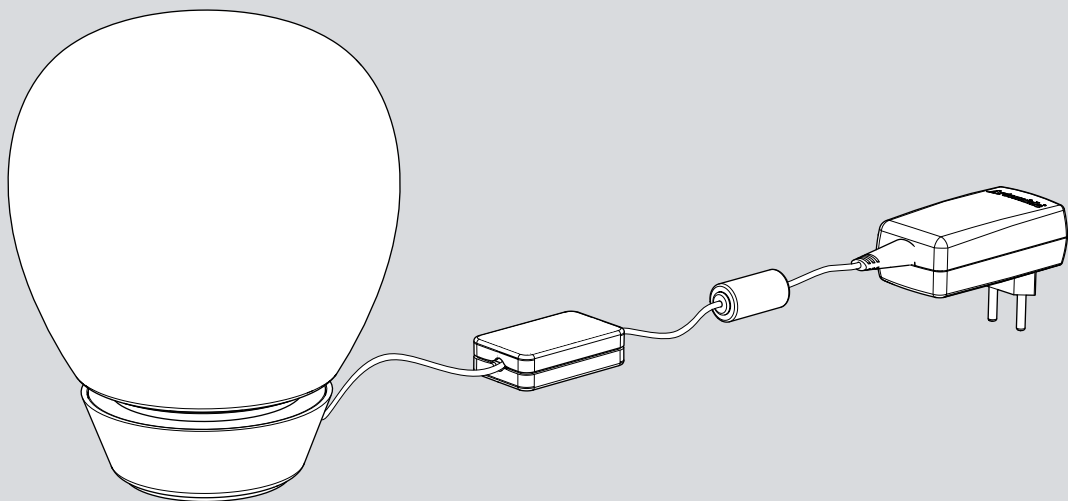



i

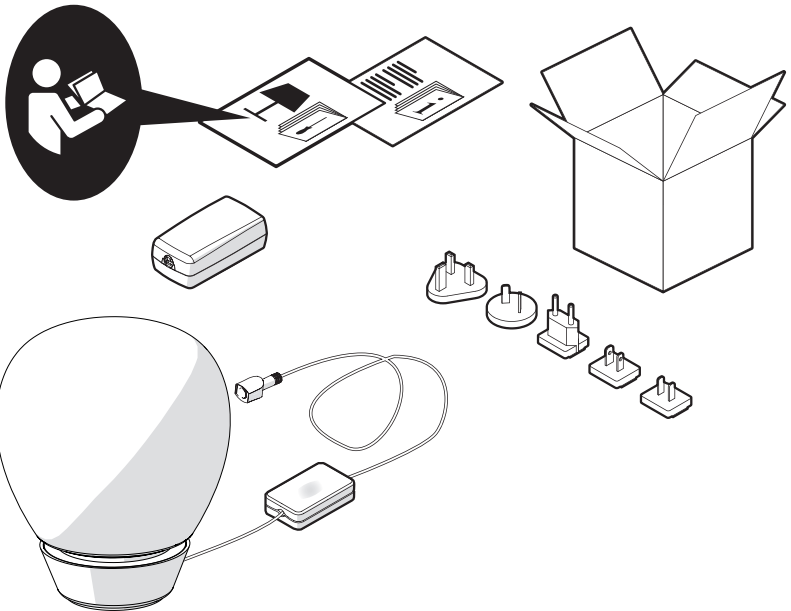
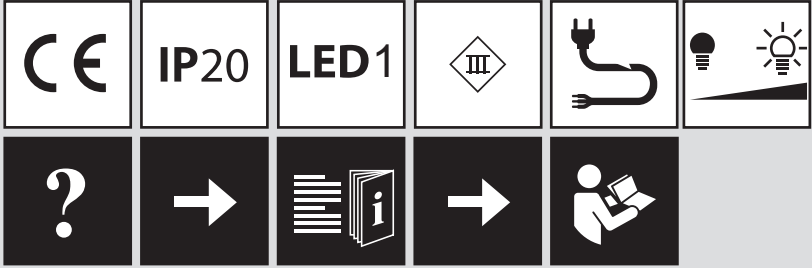

1

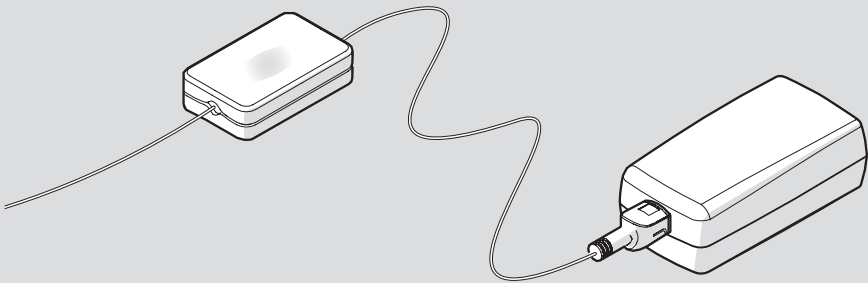
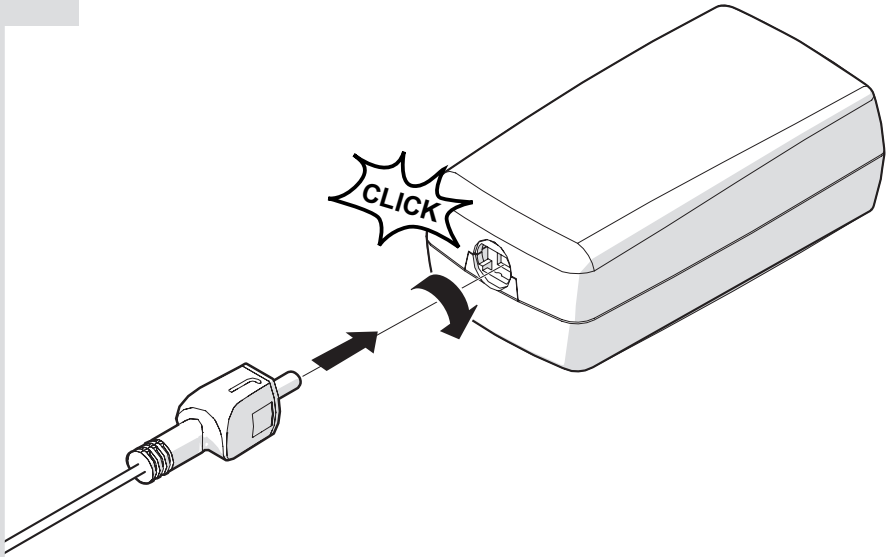



i

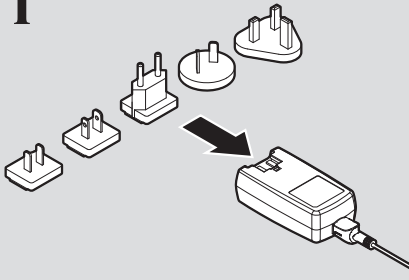

2

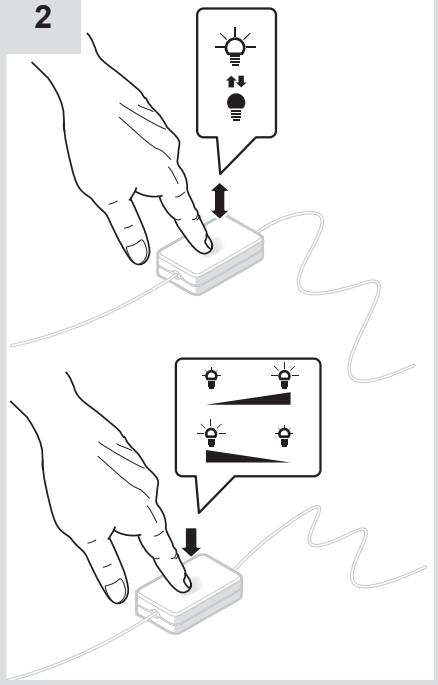

1

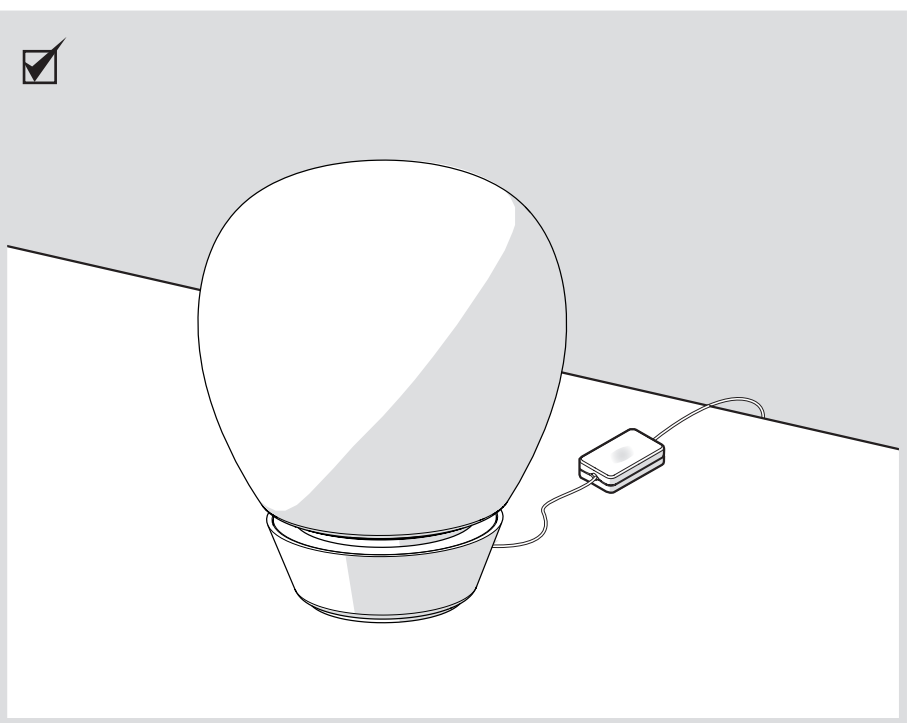
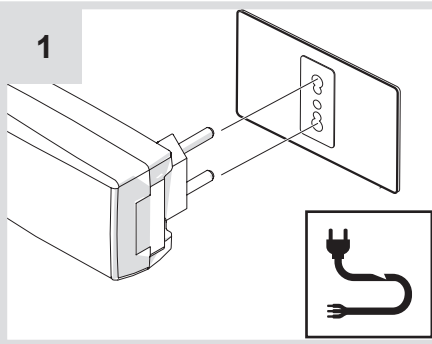

**i**



**1**

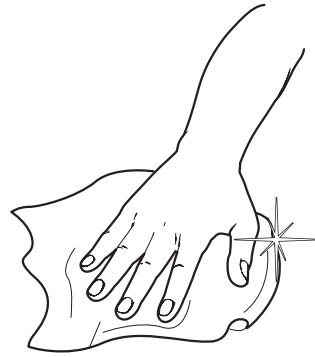





**Artemide®**



## **Artemide**

via Bergamo, 18  
20010 Pregnana M.se (MI)  
ITALIA

tel. +39 02 935 181  
fax +39 02 935 90 254  
fax +39 02 935 90 496

[www.artemide.com](http://www.artemide.com)

VAT IT00846890150

cod. Y513000181A