

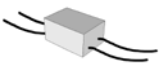

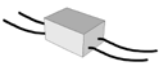

Product datasheet **LED Power Supply AC/350mA CC** code: X0\_ \_

## Description

**EN** Fully encapsulated Led driver with IP65, IP67 or IP68 level (except X040 & X073).  
 Cooling by free air convection.  
 Suitable for LED.

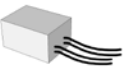
			end of life 07/2020	from 04/2020		end of life 03/2020
						
Product code : Code produit : Produkt-Code :	<b>X021</b>	<b>X020</b>	<b>X022</b>	<b>X022B</b>	<b>X037.DIM</b>	<b>X014</b>
Power : Puissance : Leistung :	0,2 - 1,4W	2 - 3,5W	1-6W	4-12W	3-10W	1-12W
Dimensions :	37 x 26 x 21 mm	37 x 26 x 21 mm	45 x 45 x 25 mm	50 x 48 x 24 mm	67 x 41 x 34 mm	81 x 35 x 23 mm
Input :	100-240V 50-60Hz	220-240V 50-60Hz	120-240V 50-60Hz	100-240V 50-60Hz	220-240V 50-60Hz	120-240V 50-60Hz
Output :	0.5-4V DC	5-10V DC	2-20V DC	11-34V DC	9-31V DC	2-35V DC
Driver type :	350 mA	350mA	350mA	350mA	350mA	350mA
Dimmable :	no	no	no	no	yes (100% -> 5%)*	no
Classification :	CE - IP65 Classe II	CE - IP65 Classe II	CE - IP67 Classe II	CE - IP65 Classe II	CE - IP67 Classe II	CE - IP67 Classe II
Working temperature :	- 25° → + 50° C					
Protections :	- Electronical internal Selfresettable short circuit - overvoltage - overtemperature					
Weight :	0,05 kg	0,05 kg	0,10 kg	0,10 kg	0,10 kg	0,17 kg
Warranty : Garantie :	2 years				2 years + 3 years optional	

\* Dimmable with leading-edge and trailing edge TRIAC dimmers

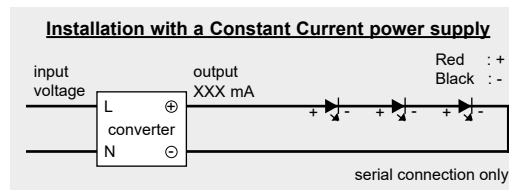

\*\* Dimmable with 0-10VDC or 1 - 10VDC



Product datasheet **LED Power Supply AC/350mA CC** code: X0\_ \_

**Description**

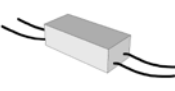
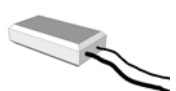
**EN** Fully encapsulated Led driver with IP65, IP67 or IP68 level (except X040 & X073).  
 Cooling by free air convection.  
 Suitable for LED.

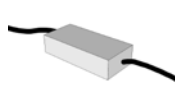
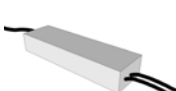
	end of life 12/2019	from 12/2019				
						
Product code :	<b>X032</b>	<b>X032B</b>	<b>X040</b>	<b>X043</b>	<b>X073</b>	<b>X074</b>
Code produit :						
Produkt-Code :						
Power :	3-18W	1-17W	16-25W	14-26W	25-37W	35-70W
Puissance :						
Leistung :						
Dimensions :	133 x 40 x 30mm	107 x 54 x 26mm	131 x 38 x 29mm	78 x 65 x 27 mm	128 x 60 x 32mm	171 x 62 x 37 mm
Input :	220-240V 50-60Hz	110-240V 50-60Hz	220-240V 50-60Hz	100-240V 50-60Hz	220-240V 50-60Hz	100-240V 50-60Hz
Output :	4-52V DC	5-49V DC	45-72V DC	38-75V DC	70-108V DC	100-200V DC
Driver type :	350mA	350mA	350mA	350mA	350mA	350mA
Dimmable :	yes(100% ->35%)*	no	yes (100% -> 5%)*	yes(100% ->10%)**	yes (100% -> 5%)*	yes(100% ->10%)**
Classification :	CE - IP66 Classe II	CE - IP68 Classe II	CE - IP20 Classe II	CE - IP66 Classe II	CE - IP42 Classe II	CE - IP67 Classe II
Working temperature :	- 25° → + 50° C					
Protections :	- Electronical internal Selfresetable short circuit - overvoltage - overtemperature					
Weight :	0,28 kg	0,25 kg	0,10 kg	0,22 kg	0,24 kg	0,73 kg
Warranty :	2 years					
Garantie :	+ 3 years optional					

\* Dimmable with leading-edge and trailing edge TRIAC dimmers  
 \*\* Dimmable with 0-10VDC or 1 - 10VDC

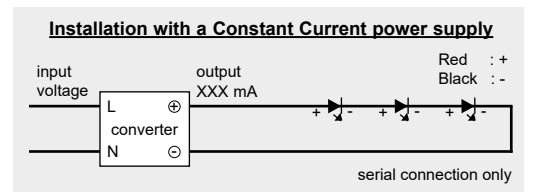





Product datasheet **LED Power Supply AC/350mA CC** code: X0\_\_

**Description**

**EN** Fully encapsulated Led driver with IP68 level (except X035 & X036).  
 Cooling by free air convection.  
 Suitable for LED.

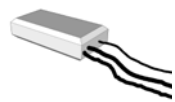
**DALI dimming**

						
			from 03/2020			
Product code :	<b>X035</b>	<b>X036</b>	<b>X070.0350</b>		<b>DIM.AC.01</b>	<b>DIM.AC.02</b>
Code produit :						
Produkt-Code :						
Power :	<a href="#">selection with DIP switch</a>	<a href="#">selection with DIP switch</a>	1-17W		synchronization cable for driver X035	synchronization cable for driver X036
Puissance :	350mA 3-18W	350mA 1-35W				
Leistung :	500mA 3-25W	500mA 1-40W				
	700mA 5-25W	700mA 1-40W				
Dimensions :	105 x 68 x 23mm	124 x 82 x 23mm	107 x 54 x 26mm		Lenght: 30cm	Lenght: 30cm
Input AC:	180-277V 50-60Hz	180-295V 50-60Hz	110-240V 50-60Hz			
Output CC :	350mA (6-54V DC) 500mA (6-50V DC) 700mA (6-36V DC)	350mA (2-100V DC) 500mA (2-80V DC) 700mA (2-57V DC)	2-49V DC			
Driver type :			350mA			
Dimmable :	DALI & push dimming	DALI & push dimming	DALI			
Classification :	CE - IP20 Classe II	CE - IP20 Classe II	CE - IP68 Classe II			
Working temperature :	- 25° → + 50° C					
Protections :	- Electronical internal Selfresettable short circuit - overvoltage - overtemperature					
Weight :	0,17 kg	0,24 kg	0,25 kg			
Warranty :	2 years					
Garantie :	+ 3 years optional					

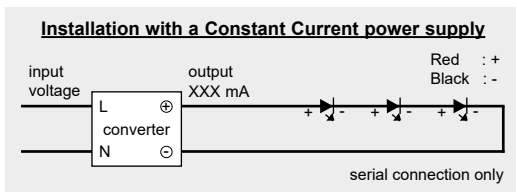

Product datasheet **LED Power Supply AC/350mA CC** code: X0\_ \_

**Installation with a DALI interface & push dimming function**

Push dimming: 10 drivers (max.) synchronization ( 1 master + 9 slaves)  
 Maximum length of the cable from first driver to last driver is 15 meter.

**DALI interface**

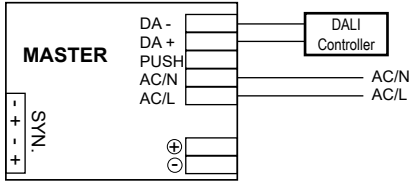

**PUSH dim**

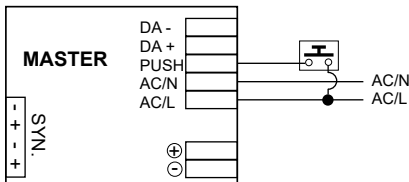

Warning: The push button can only be connected between the PUSH terminal and AC/L.  
 It would cause short circuit if it is connected to AC/N.

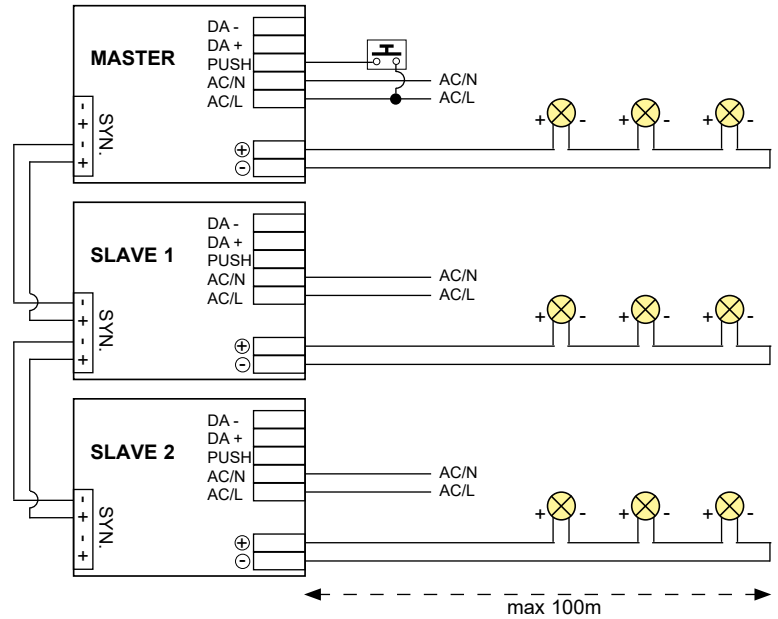

**Max. distance driver LED**

Driver constant current ( 350mA or 500mA)				
Distance	5 m	10 m	20 m	50m
Cable section	0,25 mm <sup>2</sup>	0,25 mm <sup>2</sup>	0,5 mm <sup>2</sup>	1,0 mm <sup>2</sup>

Driver constant current ( 700mA)				
Distance	5 m	10 m	20 m	50m
Cable section	0,5 mm <sup>2</sup>	0,5 mm <sup>2</sup>	1,0 mm <sup>2</sup>	2,5 mm <sup>2</sup>

Driver constant voltage ( max. 70W - 24VDC)				
Distance	5 m	10 m	20 m	30m
Cable section	0,75 mm <sup>2</sup>	1 mm <sup>2</sup>	1,5 mm <sup>2</sup>	2,5 mm <sup>2</sup>

Driver constant voltage ( max. 150W - 24VDC)				
Distance	5 m	10 m	20 m	30m
Cable section	1,5 mm <sup>2</sup>	2,5 mm <sup>2</sup>	4,0 mm <sup>2</sup>	4,0 mm <sup>2</sup>